

# Ceník výrobků

Platnost ceníku od 1. 3. 2021

Exterier Beton

# Vymývané povrchy

## Povrch obložek

OBLÁZEK 6-8



OBLÁZEK 8-10



OBLÁZEK 10-16



## Povrch standard

GRIO



NERO



ČEDIČ



FUEGO



ASO



MELZO



TAMBORA



HEKLA



GIRA

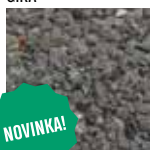

NITA



ČITA

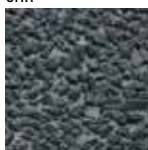

BIANCO

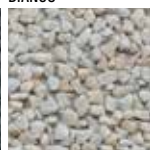

KATLA



ROSSETO



UNZEN



FUDŽI



ŽULA



## Povrch elegant

ORANŽ



ORANŽ červená



KELUT



ROSSETO bílá



FUDŽI bílá



MAGMA



LORA



ORIA



ORIA červená



KALA



BIANCO bílá



FUEGO bílá



HEKLA bílá



LONG



LOKON



## Povrch delux

SIVA



MARRONE



MARCO



MADEIRA



IPALA



COLIMA



KELUT bílá



BARI



LATE



KAO



CREMA



CARPI



COLORNO



KALA bílá



## Povrch extra delux

BARI bílá



LATE bílá



KAO bílá



CREMA bílá



CARPI bílá



COLORNO bílá



# Dlažby hladké a vymývané

Dlažby hladké				cena bez DPH / m <sup>2</sup> cena s DPH / m <sup>2</sup>
Produkt	Spotřeba ks / m <sup>2</sup>	Paletizace [m <sup>2</sup> ]	Hmotnost [kg] m <sup>2</sup> / paleta	šedá
<b>Dlažba 30 × 30 / 5</b>	11,11	6,48	110 / 713	<b>275.00</b> 332.80
<b>Dlažba 40 × 40 / 5</b>	6,25	7,04	110 / 775	<b>290.00</b> 350.90
<b>Dlažba 50 × 50 / 5</b>	4	11	110 / 1210	<b>290.00</b> 350.90
<b>Dlažba 60 × 40 / 5</b>	4,17	10,55	110 / 1160	<b>290.00</b> 350.90

Hladké plošné dlažby jsou opatřeny distančními vymešovacími prvky.

Dlažby vymývané					cena bez DPH / mj cena s DPH / mj				
Produkt		Spotřeba ks / m <sup>2</sup>	Paletizace	Hmotnost [kg] m <sup>2</sup> (ks) / paleta	obrázek 6-8, 8-10 10-16	povrch standard	povrch elegant	povrch delux	povrch extra delux
<b>Dlažba 40 × 40 / 5</b>	<b>(Kč / m<sup>2</sup>)</b>	6,25	9,6 m <sup>2</sup>	120 / 1152	<b>377.00</b> 456.20	<b>434.00</b> 525.20	<b>471.00</b> 570.00	<b>528.00</b> 638.90	<b>603.00</b> 729.70
vymytá 1 hrana	<b>(Kč / ks)</b>		60 ks	19,2 / 1152	<b>220.00</b> 266.20	<b>253.00</b> 306.20	<b>275.00</b> 332.80	<b>308.00</b> 372.70	<b>352.00</b> 426.00
vymyté 2 hrany	<b>(Kč / ks)</b>		60 ks	19,2 / 1152	<b>270.00</b> 326.70	<b>311.00</b> 376.40	<b>338.00</b> 409.00	<b>378.00</b> 457.40	<b>432.00</b> 522.80
<b>Dlažba 50 × 50 / 6</b>	<b>(Kč / m<sup>2</sup>)</b>	4	10 m <sup>2</sup>	133 / 1330	<b>399.00</b> 482.80	<b>459.00</b> 555.40	<b>499.00</b> 603.80	<b>559.00</b> 676.40	<b>638.00</b> 772.00
vymytá 1 hrana	<b>(Kč / ks)</b>		40 ks	33,25 / 1330	<b>320.00</b> 387.20	<b>368.00</b> 445.30	<b>400.00</b> 484.00	<b>448.00</b> 542.10	<b>512.00</b> 619.60
vymyté 2 hrany	<b>(Kč / ks)</b>		40 ks	33,25 / 1330	<b>370.00</b> 447.70	<b>426.00</b> 515.50	<b>463.00</b> 560.30	<b>518.00</b> 626.80	<b>592.00</b> 716.40
<b>Dlažba 60 × 40 / 5</b>	<b>(Kč / m<sup>2</sup>)</b>	4,17	9,6 m <sup>2</sup>	120 / 1152	<b>399.00</b> 482.80	<b>459.00</b> 555.40	<b>499.00</b> 603.80	<b>559.00</b> 676.40	<b>638.00</b> 772.00
vymytá 1 hrana	<b>(Kč / ks)</b>		40 ks	28,8 / 1152	<b>310.00</b> 375.10	<b>357.00</b> 432.00	<b>388.00</b> 469.50	<b>434.00</b> 525.20	<b>496.00</b> 600.20
vymyté 2 hrany	<b>(Kč / ks)</b>		40 ks	28,8 / 1152	<b>360.00</b> 435.60	<b>414.00</b> 501.00	<b>450.00</b> 544.50	<b>504.00</b> 609.90	<b>576.00</b> 697.00
<b>Šestiúhelník / 5</b>	<b>(Kč / m<sup>2</sup>)</b>	6,41	9,36 m <sup>2</sup>	120 / 1123	<b>419.00</b> 507.00	<b>482.00</b> 583.30	<b>524.00</b> 634.10	<b>587.00</b> 710.30	<b>670.00</b> 810,70
půlka typ 1, 2	<b>(Kč / m<sup>2</sup>)</b>	12,82	3,9 m <sup>2</sup>	120 / 468	<b>489.00</b> 591,70	<b>562.00</b> 680,10	<b>611.00</b> 739,40	<b>685.00</b> 828,90	<b>782.00</b> 946,30

Vymývané plošné dlažby nejsou opatřeny distančními vymešovacími prvky, proto je nutné nepokládat dlažbu na sraz.  
Vymytí hran u obkladů a dlažby – viz tabulka na straně 3.

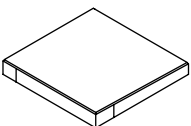
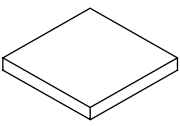
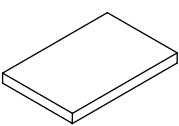
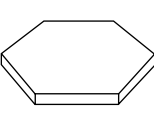
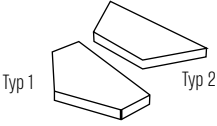
Dlažba hladká – čtverec 	Dlažba vymývaná – čtverec 	Dlažba 60 × 40 / 5 	Šestiúhelník / 5 	Šestiúhelník / 5 – typ 1, 2 
--	--	---	---	--

# Soklové obklady

Soklové obklady – 2,5 cm					cena bez DPH / mj cena s DPH / mj				
Produkt		Spotřeba ks / m <sup>2</sup>	Paletizace	Hmotnost [kg] m <sup>2</sup> (ks) / paleta	oblázek 6-8, 8-10	povrch standard	povrch elegant	povrch delux	povrch extra delux
<b>Obklad 50 × 25 / 2,5</b>	<b>(Kč / m<sup>2</sup>)</b>	8	11 m <sup>2</sup>	57,5 / 633	<b>469,00</b> 567,50	<b>539,00</b> 652,20	<b>586,00</b> 709,10	<b>657,00</b> 795,00	<b>750,00</b> 907,50
vymytá 1 hrana	<b>(Kč / ks)</b>		88 ks	7,2 / 633	<b>134,00</b> 162,20	<b>154,00</b> 186,40	<b>168,00</b> 203,30	<b>188,00</b> 227,50	<b>214,00</b> 259,00
vymyté 2 hrany	<b>(Kč / ks)</b>		88 ks	7,2 / 633	<b>184,00</b> 222,70	<b>212,00</b> 256,60	<b>230,00</b> 278,30	<b>258,00</b> 312,20	<b>294,00</b> 355,80
<b>Obklad 40 × 20 / 2,5</b>	<b>(Kč / m<sup>2</sup>)</b>	12,5	6,88 m <sup>2</sup>	57,5 / 396	<b>469,00</b> 567,50	<b>539,00</b> 652,20	<b>586,00</b> 709,10	<b>657,00</b> 795,00	<b>750,00</b> 907,50
vymytá 1 hrana	<b>(Kč / ks)</b>		86 ks	4,6 / 396	<b>89,00</b> 107,70	<b>102,00</b> 123,50	<b>111,00</b> 134,40	<b>125,00</b> 151,30	<b>142,00</b> 171,90
vymyté 2 hrany	<b>(Kč / ks)</b>		86 ks	4,6 / 396	<b>139,00</b> 168,20	<b>160,00</b> 193,60	<b>174,00</b> 210,60	<b>195,00</b> 236,00	<b>222,00</b> 268,70
<b>Obklad 30 × 30 / 2,5</b>	<b>(Kč / m<sup>2</sup>)</b>	11,11	7,20 m <sup>2</sup>	57,5 / 416	<b>469,00</b> 567,50	<b>539,00</b> 652,20	<b>586,00</b> 709,10	<b>657,00</b> 795,00	<b>750,00</b> 907,50
vymytá 1 hrana	<b>(Kč / ks)</b>		80 ks	5,2 / 416	<b>99,00</b> 119,80	<b>114,00</b> 138,00	<b>124,00</b> 150,10	<b>139,00</b> 168,20	<b>158,00</b> 191,20
vymyté 2 hrany	<b>(Kč / ks)</b>		80 ks	5,2 / 416	<b>149,00</b> 180,30	<b>171,00</b> 207,00	<b>186,00</b> 225,10	<b>209,00</b> 252,90	<b>238,00</b> 288,00
<b>Obklad 30 × 15 / 2,5</b>	<b>(Kč / m<sup>2</sup>)</b>	22,22	3,82 m <sup>2</sup>	57,5 / 219	<b>469,00</b> 567,50	<b>539,00</b> 652,20	<b>586,00</b> 709,10	<b>657,00</b> 795,00	<b>750,00</b> 907,50
vymytá 1 hrana	<b>(Kč / ks)</b>		84 ks	2,6 / 219	<b>76,00</b> 92,00	<b>87,00</b> 105,30	<b>95,00</b> 115,00	<b>106,00</b> 128,30	<b>122,00</b> 147,70
vymyté 2 hrany	<b>(Kč / ks)</b>		84 ks	2,6 / 219	<b>126,00</b> 152,50	<b>145,00</b> 175,50	<b>158,00</b> 191,20	<b>176,00</b> 213,00	<b>202,00</b> 244,50
<b>Obklad 50 × 10 / 2,5</b>	<b>(Kč / m<sup>2</sup>)</b>	20	6,6 m <sup>2</sup>	57,5 / 379,5	<b>469,00</b> 567,50	<b>539,00</b> 652,20	<b>586,00</b> 709,10	<b>657,00</b> 795,00	<b>750,00</b> 907,50
vymytá 1 hrana	<b>(Kč / ks)</b>		86 ks	3 / 258	<b>83,00</b> 100,50	<b>95,00</b> 115,00	<b>104,00</b> 125,90	<b>116,00</b> 140,40	<b>133,00</b> 161,00
vymyté 2 hrany	<b>(Kč / ks)</b>		86 ks	3 / 258	<b>133,00</b> 161,00	<b>153,00</b> 185,20	<b>166,00</b> 200,90	<b>186,00</b> 225,10	<b>213,00</b> 257,80
<b>Obklad 60 × 10 / 2,5</b>	<b>(Kč / m<sup>2</sup>)</b>	16,66	7,92 m <sup>2</sup>	57,5 / 455	<b>469,00</b> 567,50	<b>539,00</b> 652,20	<b>586,00</b> 709,10	<b>657,00</b> 795,00	<b>750,00</b> 907,50
vymytá 1 hrana	<b>(Kč / ks)</b>		86 ks	3,5 / 301	<b>92,00</b> 111,40	<b>106,00</b> 128,30	<b>115,00</b> 139,20	<b>129,00</b> 156,10	<b>147,00</b> 177,90
vymyté 2 hrany	<b>(Kč / ks)</b>		86 ks	3,5 / 301	<b>142,00</b> 171,90	<b>163,00</b> 197,30	<b>178,00</b> 215,40	<b>199,00</b> 240,80	<b>227,00</b> 274,70

## Soklové obklady – 3 cm

cena bez DPH / mj  
cena s DPH / mj

Produkt		Spotřeba ks / m <sup>2</sup>	Paletizace	Hmotnost [kg] m <sup>2</sup> (ks) / paleta	obláček 6-8, 8-10 10-16	povrch standard	povrch elegant	povrch delux	povrch extra delux
<b>Obklad 40 × 40 / 3</b>	<b>(Kč / m<sup>2</sup>)</b>	6,25	9,6 m <sup>2</sup>	70 / 672	<b>469,00</b> 567,50	<b>539,00</b> 652,20	<b>586,00</b> 709,10	<b>657,00</b> 795,00	<b>750,00</b> 907,50
vymytá 1 hrana	<b>(Kč / ks)</b>		60 ks	11,2 / 672	<b>175,00</b> 211,80	<b>201,00</b> 243,30	<b>219,00</b> 265,00	<b>245,00</b> 296,50	<b>280,00</b> 338,80
vymyté 2 hrany	<b>(Kč / ks)</b>		60 ks	11,2 / 672	<b>225,00</b> 272,30	<b>259,00</b> 313,40	<b>281,00</b> 340,10	<b>315,00</b> 381,20	<b>360,00</b> 435,60
<b>Obklad 60 × 30 / 3</b>	<b>(Kč / m<sup>2</sup>)</b>	5,55	7,20 m <sup>2</sup>	70 / 504	<b>469,00</b> 567,50	<b>539,00</b> 652,20	<b>586,00</b> 709,10	<b>657,00</b> 795,00	<b>750,00</b> 907,50
vymytá 1 hrana	<b>(Kč / ks)</b>		40 ks	12,6 / 504	<b>198,00</b> 239,60	<b>228,00</b> 275,90	<b>248,00</b> 300,10	<b>277,00</b> 335,20	<b>317,00</b> 383,60
vymyté 2 hrany	<b>(Kč / ks)</b>		40 ks	12,6 / 504	<b>248,00</b> 300,10	<b>285,00</b> 344,90	<b>310,00</b> 375,10	<b>347,00</b> 419,90	<b>397,00</b> 480,40

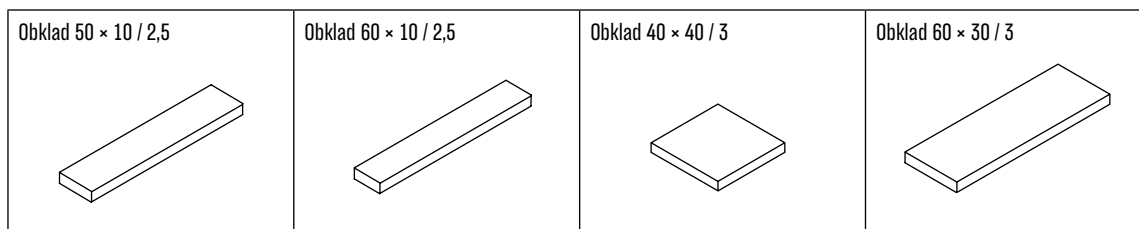
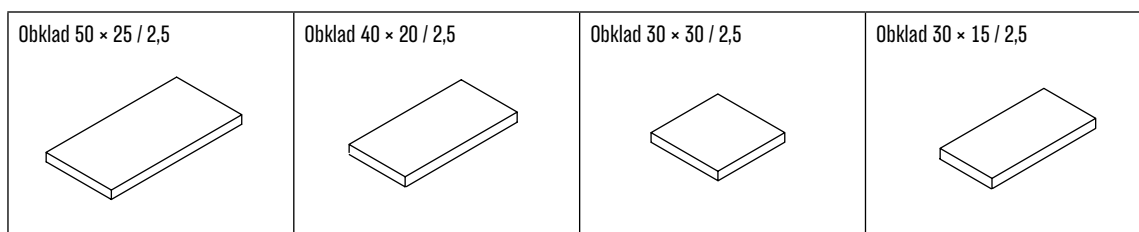

### VYMYTÍ HRAN U OBKLADŮ A DLAŽBY:

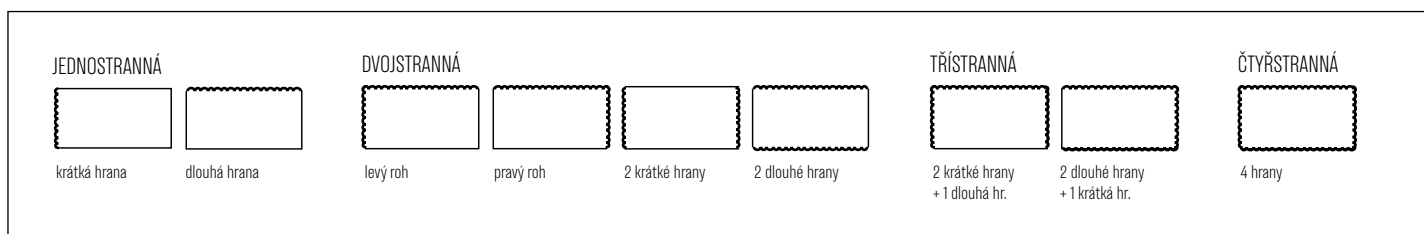

# Výseče a nášlapy

Produkt	Skladebná délka v cm začáteční / průběžná / koncová	Paletizace [ks]	Hmotnost [kg] ks / paleta	obložek 6-8, 8-10 10-16	cena bez DPH / ks cena s DPH / ks			
					povrch standard	povrch elegant	povrch delux	povrch extra delux
<b>Výseč Ø 50 / 5</b>	34,5 / 35 / 19,5	60	18 / 1080	<b>155.00</b> 187.60	<b>178.00</b> 215.40	<b>194.00</b> 234.80	<b>217.00</b> 262.60	<b>248.00</b> 300.10
<b>Výseč Ø 60 / 5</b>	39 / 40 / 21	40	25 / 1000	<b>238.00</b> 288.00	<b>274.00</b> 331.60	<b>298.00</b> 360.60	<b>333.00</b> 403.00	<b>381.00</b> 461.10
<b>Výseč Ø 70 / 5</b>	45 / 46 / 21,5	20	32 / 640	<b>332.00</b> 401.80	<b>382.00</b> 462.30	<b>415.00</b> 502.20	<b>465.00</b> 562.70	<b>531.00</b> 642.60
<b>Výseč Ø 80 / 5</b>	53 / 54 / 27	20	50 / 1000	<b>509.00</b> 615.90	<b>585.00</b> 707.90	<b>636.00</b> 769.60	<b>713.00</b> 862.80	<b>814.00</b> 985.00
<b>Výseč Ø 100 / 6</b>	68 / 69 / 37	6	83 / 498	<b>583.00</b> 705.50	<b>670.00</b> 810.70	<b>729.00</b> 882.10	<b>816.00</b> 987.40	<b>933.00</b> 1129.00
<b>Výseč Ø 120 / 6</b>	79 / 80 / 40	5	100 / 500	<b>749.00</b> 906.30	<b>861.00</b> 1041.90	<b>936.00</b> 1132.60	<b>1049.00</b> 1269.30	<b>1198.00</b> 1449.60

Cena začátečních a koncových výsečí je stejná jako průběžných výsečí.

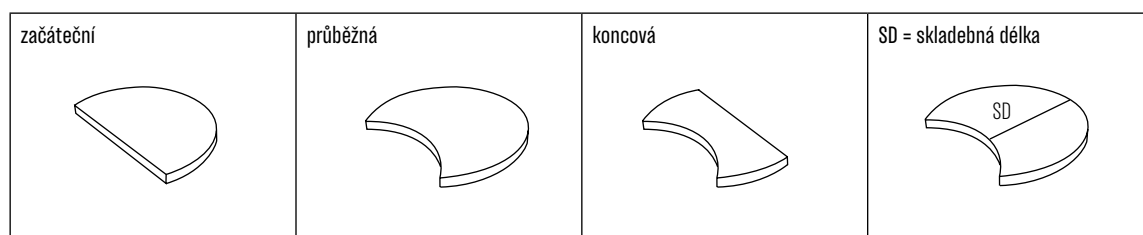

Produkt	Skladebná délka v cm	Paletizace [ks]	Hmotnost [kg] ks / paleta	obložek 6-8, 8-10 10-16	cena bez DPH / ks cena s DPH / ks			
					povrch standard	povrch elegant	povrch delux	povrch extra delux
<b>Výseč Ø 70 / 20</b> začáteční	45	6	63 / 378	<b>823.00</b> 995.90	<b>946.00</b> 1144.70	<b>1029.00</b> 1245.10	<b>1152.00</b> 1394.00	<b>1317.00</b> 1593.60
<b>Výseč Ø 70 / 20</b> průběžná	46	6	63 / 378	<b>823.00</b> 995.90	<b>946.00</b> 1144.70	<b>1029.00</b> 1245.10	<b>1152.00</b> 1394.00	<b>1317.00</b> 1593.60

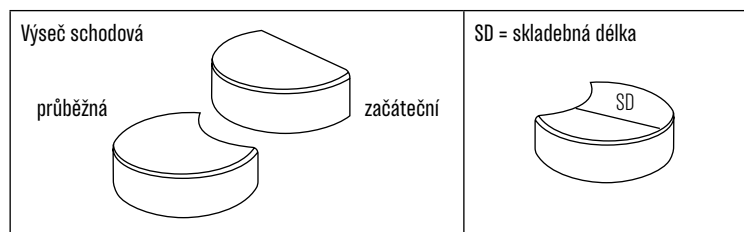

Nášlapy		cena bez DPH / ks						
		cena s DPH / ks						
Produkt	Paletizace [ks]	Hmotnost [kg] ks / paleta	oblázek 6-8, 8-10 10-16	povrch standard	povrch elegant	povrch delux	povrch extra delux	
<b>Nášlap kruhový Ø 40 / 5</b>	60	13 / 780	<b>139.00</b> 168.20	<b>160.00</b> 193.60	<b>174.00</b> 210.60	<b>195.00</b> 236.00	<b>222.00</b> 268.70	
<b>Nášlap kruhový Ø 50 / 5</b>	40	21 / 840	<b>164.00</b> 198.50	<b>189.00</b> 228.70	<b>205.00</b> 248.10	<b>230.00</b> 278.30	<b>262.00</b> 317.10	
<b>Nášlap kruhový Ø 60 / 5</b>	20	30 / 600	<b>269.00</b> 325.50	<b>309.00</b> 373.90	<b>336.00</b> 406.60	<b>377.00</b> 456.20	<b>430.00</b> 520.30	
<b>Nášlap kruhový Ø 70 / 5</b>	10	42 / 420	<b>389.00</b> 470.70	<b>447.00</b> 540.90	<b>486.00</b> 588.10	<b>545.00</b> 659.50	<b>622.00</b> 752.70	
<b>Nášlap kruhový Ø 80 / 5</b>	10	58 / 580	<b>619.00</b> 749.00	<b>712.00</b> 861.60	<b>774.00</b> 936.60	<b>867.00</b> 1049.10	<b>990.00</b> 1197.90	
<b>Nášlap Luna 40 × 40 / 5</b>	60	14 / 840	<b>107.00</b> 129.50	<b>123.00</b> 148.90	<b>134.00</b> 162.20	<b>150.00</b> 181.50	<b>171.00</b> 207.00	
<b>Nášlap Jetty 50 × 27 / 5 (levý, pravý)</b>		12 / -	<b>157.00</b> 190.00	<b>181.00</b> 219.10	<b>196.00</b> 237.20	<b>220.00</b> 266.20	<b>251.00</b> 303.80	

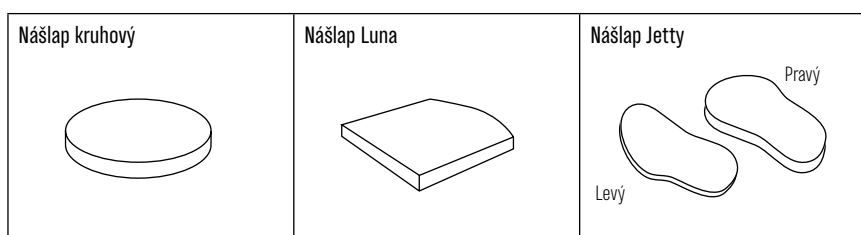

# Bazénové prvky

Bazénové obklady					cena bez DPH / ks cena s DPH / ks			
Produkt	Spotřeba ks / m <sup>2</sup>	Paletizace [ks]	Hmotnost [kg] ks / paleta	obložek 6-8, 8-10 10-16	povrch standard	povrch elegant	povrch delux	povrch extra delux
<b>Obklad 40 × 40 / 4</b>	6,25	60	13,5 / 810	<b>89,00</b> 107,70	<b>102,00</b> 123,50	<b>111,00</b> 134,40	<b>125,00</b> 151,30	<b>142,00</b> 171,90
vymytá 1 hrana		60	13,5 / 810	<b>220,00</b> 266,20	<b>253,00</b> 306,20	<b>275,00</b> 332,80	<b>308,00</b> 372,70	<b>352,00</b> 426,00
vymyté 2 hrany		60	13,5 / 810	<b>270,00</b> 326,70	<b>311,00</b> 376,40	<b>338,00</b> 409,00	<b>378,00</b> 457,40	<b>432,00</b> 522,80
<b>Obklad 50 × 50 / 4</b>	4	40	21 / 840	<b>139,00</b> 168,20	<b>160,00</b> 193,60	<b>174,00</b> 210,60	<b>195,00</b> 236,00	<b>222,00</b> 268,70
vymytá 1 hrana		40	21 / 840	<b>320,00</b> 387,20	<b>368,00</b> 445,30	<b>400,00</b> 484,00	<b>448,00</b> 542,10	<b>512,00</b> 619,60
vymyté 2 hrany		40	21 / 840	<b>370,00</b> 447,70	<b>426,00</b> 515,50	<b>463,00</b> 560,30	<b>518,00</b> 626,80	<b>592,00</b> 716,40
<b>Obklad 60 × 40 / 4</b>	4,17	40	20 / 800	<b>133,00</b> 161,00	<b>153,00</b> 185,20	<b>166,00</b> 200,90	<b>186,00</b> 225,10	<b>213,00</b> 257,80
vymytá 1 hrana		40	20 / 800	<b>310,00</b> 375,10	<b>357,00</b> 432,00	<b>388,00</b> 469,50	<b>434,00</b> 525,20	<b>496,00</b> 600,20
vymyté 2 hrany		40	20 / 800	<b>360,00</b> 435,60	<b>414,00</b> 501,00	<b>450,00</b> 544,50	<b>504,00</b> 609,90	<b>576,00</b> 697,00
<b>Obklad 60 × 50 / 4</b>	3,33	40	26 / 1040	<b>167,00</b> 202,10	<b>192,00</b> 232,40	<b>209,00</b> 252,90	<b>234,00</b> 283,20	<b>267,00</b> 323,10
vymytá 1 hrana		40	26 / 1040	<b>370,00</b> 447,70	<b>426,00</b> 515,50	<b>463,00</b> 560,30	<b>518,00</b> 626,80	<b>592,00</b> 716,40
vymyté 2 hrany		40	26 / 1040	<b>420,00</b> 508,20	<b>483,00</b> 584,50	<b>525,00</b> 635,30	<b>588,00</b> 711,50	<b>672,00</b> 813,20

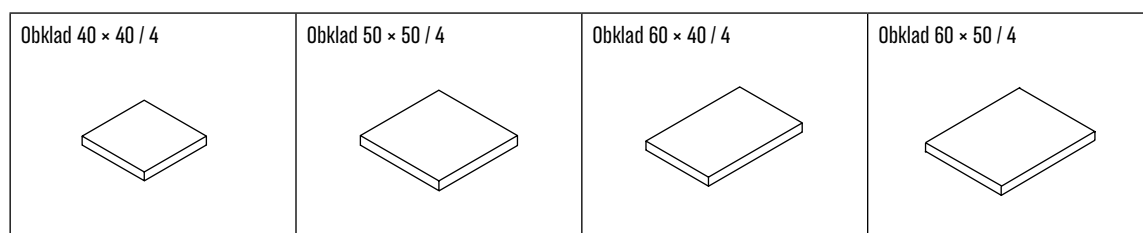

## VYMYTÍ HRAN U OBKLADŮ A DLAŽBY:

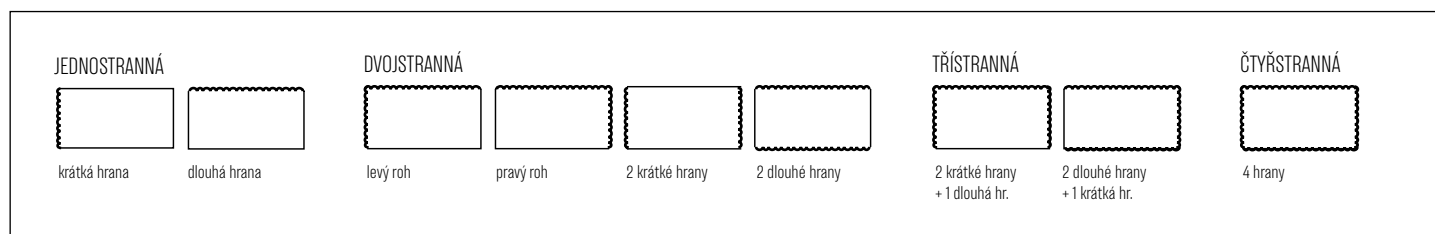



Bazénové výseče					cena bez DPH / ks cena s DPH / ks			
Produkt	Paletizace [ks]	Hmotnost [kg] ks / paleta	obláček 6-8, 8-10 10-16	povrch standard	povrch elegant	povrch delux	povrch extra delux	
<b>Segment na Ø 3 m</b> ostrá nepohledová hrana b)	36	18 / 648	<b>166.00</b> 200.90	<b>191.00</b> 231.20	<b>208.00</b> 251.70	<b>232.00</b> 280.80	<b>266.00</b> 321.90	
<b>Segment na Ø 3 m</b> vymývaná hrana a)	36	18 / 648	<b>276.00</b> 334.00	<b>317.00</b> 383.60	<b>345.00</b> 417.50	<b>386.00</b> 467.10	<b>442.00</b> 534.90	
<b>Segment na Ø 4 m</b> ostrá nepohledová hrana b)	36	23 / 828	<b>230.00</b> 278.30	<b>265.00</b> 320.70	<b>288.00</b> 348.50	<b>322.00</b> 389.70	<b>368.00</b> 445.30	
<b>Segment na Ø 4 m</b> vymývaná hrana a)	36	23 / 828	<b>340.00</b> 411.40	<b>391.00</b> 473.20	<b>425.00</b> 514.30	<b>476.00</b> 576.00	<b>544.00</b> 658.30	
<b>Segment na Ø 5 m</b> ostrá nepohledová hrana b)	36	28 / 1008	<b>317.00</b> 383.60	<b>365.00</b> 441.70	<b>396.00</b> 479.20	<b>444.00</b> 537.30	<b>507.00</b> 613.50	
<b>Segment na Ø 5 m</b> vymývaná hrana a)	36	28 / 1008	<b>427.00</b> 516.70	<b>491.00</b> 594.20	<b>534.00</b> 646.20	<b>598.00</b> 723.60	<b>683.00</b> 826.50	
Segment 10° 36 ks do kruhu, segmenty Ø 3 m, 4 m a 5 m na sebe navazují.								
<b>Segment na Ø 3,6 m</b> ostrá nepohledová hrana b)	36	20 / 720	<b>213.00</b> 257.80	<b>245.00</b> 296.50	<b>266.00</b> 321.90	<b>298.00</b> 360.60	<b>341.00</b> 412.70	
<b>Segment na Ø 3,6 m</b> vymývaná hrana a)	36	20 / 720	<b>323.00</b> 390.90	<b>371.00</b> 449.00	<b>404.00</b> 488.90	<b>452.00</b> 547.00	<b>517.00</b> 625.60	
<b>Segment na Ø 4,6 m</b> ostrá nepohledová hrana b)	36	25 / 900	<b>277.00</b> 335.20	<b>319.00</b> 386.00	<b>346.00</b> 418.70	<b>388.00</b> 469.50	<b>443.00</b> 536.10	
<b>Segment na Ø 4,6 m</b> vymývaná hrana a)	36	25 / 900	<b>387.00</b> 468.30	<b>445.00</b> 538.50	<b>484.00</b> 585.70	<b>542.00</b> 655.90	<b>619.00</b> 749.00	
Segment 10° 36 ks do kruhu, segmenty Ø 3,6 a 4,6 m na sebe navazují.								
<b>Segment na Ø 5,5 m</b> ostrá nepohledová hrana b)	48	22,5 / 1080	<b>250.00</b> 302.50	<b>288.00</b> 348.50	<b>313.00</b> 378.80	<b>350.00</b> 423.50	<b>400.00</b> 484.00	
<b>Segment na Ø 5,5 m</b> vymývaná hrana a)	48	22,5 / 1080	<b>360.00</b> 435.60	<b>414.00</b> 501.00	<b>450.00</b> 544.50	<b>504.00</b> 609.90	<b>576.00</b> 697.00	
Segment 7,5° 48 ks do kruhu. Bazénové výseče mají přední hrana ostrou betonovou.								

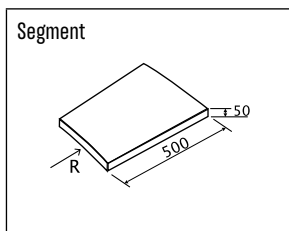

#### UKONČENÍ ZADNÍ HRANY:

a) zadní hrana sražená vymytá	b) zadní hrana ostrá betonová	Řez

# Bazénové prvky

Bazénové lemy – typ DESKA				cena bez DPH / ks cena s DPH / ks			
Produkt	Hmotnost [kg]	Radius R [mm]	obláček 6-8, 8-10 10-16	povrch standard	povrch elegant	povrch delux	povrch extra delux
<b>Rovný lem DESKA</b> 100 / 39,5	34	-	<b>819.00</b> 991.00	<b>942.00</b> 1139.90	<b>1024.00</b> 1239.10	<b>1147.00</b> 1387.90	<b>1310.00</b> 1585.10
<b>Roh 1 DESKA</b> vnitřní roh ostrý 90°	20	-	<b>658.00</b> 796.20	<b>757.00</b> 916.00	<b>823.00</b> 995.90	<b>921.00</b> 1114.50	<b>1053.00</b> 1274.20
<b>Roh 3 DESKA</b>							
vnitřní roh Ø 0,21 m ostrý	20	105	<b>658.00</b> 796.20	<b>757.00</b> 916.00	<b>823.00</b> 995.90	<b>921.00</b> 1114.50	<b>1053.00</b> 1274.20
vnitřní roh Ø 1 m ostrý	47	500	<b>1228.00</b> 1485.90	<b>1412.00</b> 1708.60	<b>1535.00</b> 1857.40	<b>1719.00</b> 2080.00	<b>1965.00</b> 2377.70
vnitřní roh Ø 1,2 m ostrý	56	600	<b>1389.00</b> 1680.70	<b>1597.00</b> 1932.40	<b>1736.00</b> 2100.60	<b>1945.00</b> 2353.50	<b>2222.00</b> 2688.70

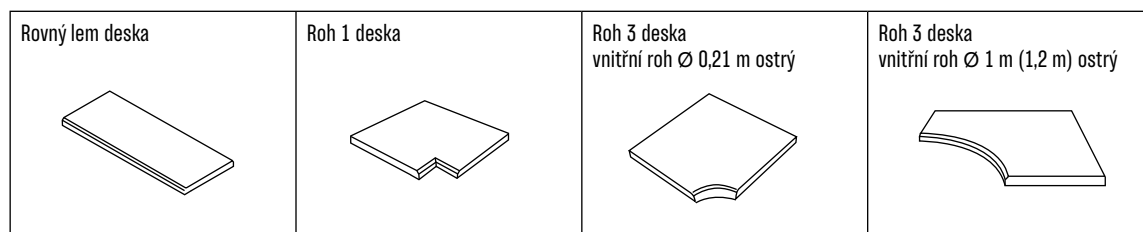

## UKONČENÍ ZADNÍ HRANY:

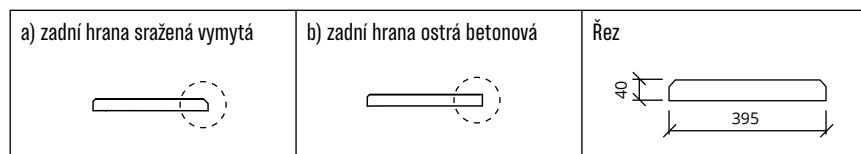

Bazénový lem – U typ				cena bez DPH / ks cena s DPH / ks			
Produkt	Hmotnost [kg]	obláček 6-8, 8-10 10-16	povrch standard	povrch elegant	povrch delux	povrch extra delux	
<b>Rovný lem U typ</b> 100 / 53	60	<b>995.00</b> 1204.00	<b>1144.00</b> 1384.30	<b>1244.00</b> 1505.30	<b>1393.00</b> 1685.60	<b>1592.00</b> 1926.40	

## Sprchová vanička

<b>Sprchová vanička</b> 80,5 × 80,5 / 10	75	<b>1562.00</b> 1890.10	<b>1796.00</b> 2173.20	<b>1953.00</b> 2363.20	<b>2187.00</b> 2646.30	<b>2499.00</b> 3023.80
--	----	---------------------------	---------------------------	---------------------------	---------------------------	---------------------------

Umělohmotná vpust' 10 × 10cm.

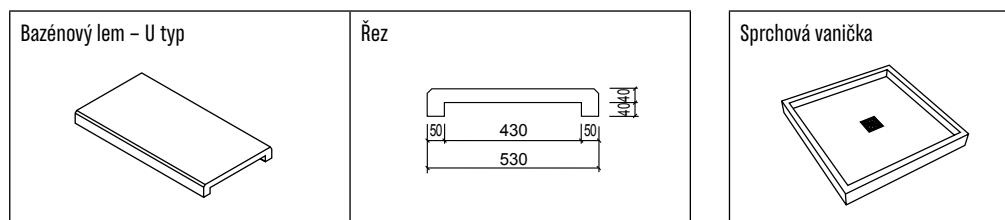

Bazénové lemy – L typ				cena bez DPH / ks cena s DPH / ks			
Produkt	Hmotnost [kg]	Radius R [mm]	obláček 6-8, 8-10 10-16	povrch standard	povrch elegant	povrch delux	povrch extra delux
<b>Rovný lem L typ</b> 100 / 39,5	37		<b>754.00</b> 912.40	<b>867.00</b> 1049.10	<b>943.00</b> 1141.10	<b>1056.00</b> 1277.80	<b>1206.00</b> 1459.30
<b>Roh 1 L typ</b> vnitřní roh ostrý 90°	21		<b>631.00</b> 763.60	<b>726.00</b> 878.50	<b>789.00</b> 954.70	<b>883.00</b> 1068.50	<b>1010.00</b> 1222.10
<b>Roh 2 L typ</b> vnitřní roh Ø 1 m zaoblený	34	500	<b>946.00</b> 1144.70	<b>1088.00</b> 1316.50	<b>1183.00</b> 1431.50	<b>1324.00</b> 1602.10	<b>1514.00</b> 1832.00
<b>Roh 3 Ltyp</b>							
vnitřní roh Ø 1 m ostrý	49	500	<b>1070.00</b> 1294.70	<b>1231.00</b> 1489.60	<b>1338.00</b> 1619.00	<b>1498.00</b> 1812.60	<b>1712.00</b> 2071.60
vnitřní roh Ø 1,2 m ostrý	58	600	<b>1298.00</b> 1570.60	<b>1493.00</b> 1806.60	<b>1623.00</b> 1963.90	<b>1817.00</b> 2198.60	<b>2077.00</b> 2513.20
<b>Roh 4 L typ</b> vnější roh ostrý 90°	22		<b>631.00</b> 763.60	<b>726.00</b> 878.50	<b>789.00</b> 954.70	<b>883.00</b> 1068.50	<b>1010.00</b> 1222.10
<b>Roh 5 L typ</b> vnější roh Ø 1 m	23	500	<b>631.00</b> 763.60	<b>726.00</b> 878.50	<b>789.00</b> 954.70	<b>883.00</b> 1068.50	<b>1010.00</b> 1222.10
<b>Kruhový segment L typ</b>							
Ø 1,9 m	23	950	<b>754.00</b> 912.40	<b>867.00</b> 1049.10	<b>943.00</b> 1141.10	<b>1056.00</b> 1277.80	<b>1206.00</b> 1459.30
Ø 2 m	24	1000	<b>754.00</b> 912.40	<b>867.00</b> 1049.10	<b>943.00</b> 1141.10	<b>1056.00</b> 1277.80	<b>1206.00</b> 1459.30
Kruhové segmenty Ø 1,9 a 2 m – segmenty 30° (12 ks do kruhu).							
Ø 3 m	17	1500	<b>514.00</b> 622.00	<b>591.00</b> 715.20	<b>643.00</b> 778.10	<b>720.00</b> 871.20	<b>822.00</b> 994.70
Ø 4 m	21	2000	<b>618.00</b> 747.80	<b>711.00</b> 860.40	<b>773.00</b> 935.40	<b>865.00</b> 1046.70	<b>989.00</b> 1196.70
Ø 5 m	28	2500	<b>717.00</b> 867.60	<b>825.00</b> 998.30	<b>896.00</b> 1084.20	<b>1004.00</b> 1214.90	<b>1147.00</b> 1387.90
Ø 6 m	34	3000	<b>823.00</b> 995.90	<b>946.00</b> 1144.70	<b>1029.00</b> 1245.10	<b>1152.00</b> 1394.00	<b>1317.00</b> 1593.60
Kruhové segmenty Ø 3, 4, 5 a 6 m – segmenty 15° (24 ks do kruhu).							

Rovný lem L typ 	Roh 1 L typ 	Roh 2 L typ 	Roh 3 Ltyp 
Roh 4 L typ 	Roh 5 L typ 	Kruhový segment L typ 	

#### UKONČENÍ ZADNÍ HRANY:

a) zadní hrana sražená vymytá 	b) zadní hrana ostrá betonová 	Řez 
-----------------------------------	-----------------------------------	---------

# Schodišťové prvky obkladové

Obklady L typ vnější				cena bez DPH / ks cena s DPH / ks			
Produkt	Paletizace [ks]	Hmotnost [kg] ks / paleta	obložek 6-8, 8-10 10-16	povrch standard	povrch elegant	povrch delux	povrch extra delux
<b>150 × 30 / 17</b>	12	62 / 744	<b>1392.00</b> 1684.40	<b>1601.00</b> 1937.30	<b>1740.00</b> 2105.40	<b>1949.00</b> 2358.30	<b>2227.00</b> 2694.70
<b>120 × 30 / 17</b>	12	50 / 600	<b>1113.00</b> 1346.80	<b>1280.00</b> 1548.80	<b>1391.00</b> 1683.20	<b>1558.00</b> 1885.20	<b>1781.00</b> 2155.10
<b>100 × 30 / 17</b>	12	41 / 492	<b>926.00</b> 1120.50	<b>1065.00</b> 1288.70	<b>1158.00</b> 1401.20	<b>1296.00</b> 1568.20	<b>1482.00</b> 1793.30
<b>150 × 34 / 17</b>	12	68 / 816	<b>1600.00</b> 1936.00	<b>1840.00</b> 2226.40	<b>2000.00</b> 2420.00	<b>2240.00</b> 2710.40	<b>2560.00</b> 3097.60
<b>120 × 34 / 17</b>	12	55 / 660	<b>1287.00</b> 1557.30	<b>1480.00</b> 1790.80	<b>1609.00</b> 1946.90	<b>1802.00</b> 2180.50	<b>2059.00</b> 2491.40
<b>100 × 34 / 17</b>	12	45 / 540	<b>1057.00</b> 1279.00	<b>1216.00</b> 1471.40	<b>1321.00</b> 1598.50	<b>1480.00</b> 1790.80	<b>1691.00</b> 2046.20

Možnost úpravy délky, max. 150cm.

Obklady L typ vnitřní				cena bez DPH / ks cena s DPH / ks			
Produkt	Paletizace [ks]	Hmotnost [kg] ks / paleta	obložek 6-8, 8-10 10-16	povrch standard	povrch elegant	povrch delux	povrch extra delux
<b>150 × 30 / 18</b>	12	62 / 744	<b>1392.00</b> 1684.40	<b>1601.00</b> 1937.30	<b>1740.00</b> 2105.40	<b>1949.00</b> 2358.30	<b>2227.00</b> 2694.70
<b>120 × 30 / 18</b>	12	50 / 600	<b>1113.00</b> 1346.80	<b>1280.00</b> 1548.80	<b>1391.00</b> 1683.20	<b>1558.00</b> 1885.20	<b>1781.00</b> 2155.10
<b>100 × 30 / 18</b>	12	41 / 492	<b>926.00</b> 1120.50	<b>1065.00</b> 1288.70	<b>1158.00</b> 1401.20	<b>1296.00</b> 1568.20	<b>1482.00</b> 1793.30

Možnost úpravy délky, max. 150cm.  
Lze upravit výšku 14, 15, 16, 17 cm.

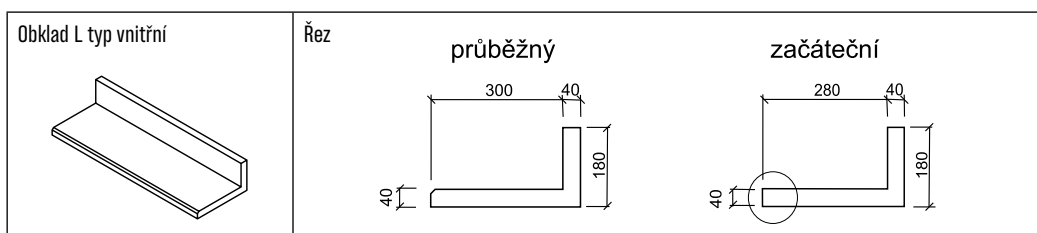
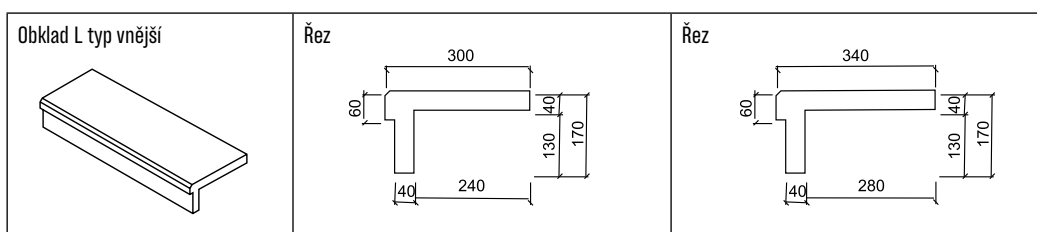

Nášlapy a podstupnice				cena bez DPH / ks cena s DPH / ks			
Produkt	Paletizace [ks]	Hmotnost [kg] ks / paleta	obláček 6-8, 8-10 10-16	povrch standard	povrch elegant	povrch delux	povrch extra delux
<b>150 × 30 / 4</b>	20	41,5 / 830	<b>1137.00</b> 1375.80	<b>1308.00</b> 1582.70	<b>1421.00</b> 1719.50	<b>1592.00</b> 1926.40	<b>1819.00</b> 2201.00
<b>120 × 30 / 4</b>	20	33 / 660	<b>910.00</b> 1101.10	<b>1047.00</b> 1266.90	<b>1138.00</b> 1377.00	<b>1274.00</b> 1541.60	<b>1456.00</b> 1761.80
<b>100 × 30 / 4</b>	20	27,5 / 550	<b>758.00</b> 917.20	<b>872.00</b> 1055.20	<b>948.00</b> 1147.10	<b>1061.00</b> 1283.90	<b>1213.00</b> 1467.80
Zakázková výroba i jiné rozměry.							
<b>150 × 14 / 3</b>	60	14,5 / 870	<b>398.00</b> 481.60	<b>458.00</b> 554.20	<b>498.00</b> 602.60	<b>557.00</b> 674.00	<b>637.00</b> 770.80
<b>120 × 14 / 3</b>	60	11,5 / 690	<b>317.00</b> 383.60	<b>365.00</b> 441.70	<b>396.00</b> 479.20	<b>444.00</b> 537.30	<b>507.00</b> 613.50
<b>100 × 14 / 3</b>	80	10 / 800	<b>264.00</b> 319.50	<b>304.00</b> 367.90	<b>330.00</b> 399.30	<b>370.00</b> 447.70	<b>422.00</b> 510.70
<b>150 × 12 / 3</b>	60	12,5 / 750	<b>340.00</b> 411.40	<b>391.00</b> 473.20	<b>425.00</b> 514.30	<b>476.00</b> 576.00	<b>544.00</b> 658.30
<b>120 × 12 / 3</b>	60	10 / 600	<b>272.00</b> 329.20	<b>313.00</b> 378.80	<b>340.00</b> 411.40	<b>381.00</b> 461.10	<b>435.00</b> 526.40
<b>100 × 12 / 3</b>	80	8 / 640	<b>227.00</b> 274.70	<b>261.00</b> 315.90	<b>284.00</b> 343.70	<b>318.00</b> 384.80	<b>363.00</b> 439.30

Zakázková výroba i jiné rozměry.

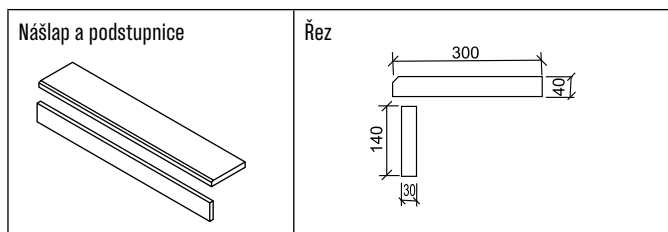

Schodišťové bloky				cena bez DPH / ks cena s DPH / ks				
Produkt	Paletizace [ks]	Hmotnost [kg] ks / paleta	hladký beton	obláček 6-8, 8-10 10-16	povrch standard	povrch elegant	povrch delux	povrch extra delux
<b>60 × 35 / 17</b>	9	82 / 738	<b>797.00</b> 964.40	<b>869.00</b> 1051.50	<b>999.00</b> 1208.80	<b>1086.00</b> 1314.10	<b>1217.00</b> 1472.60	<b>1390.00</b> 1681.90
<b>50 × 35 / 17</b>	9	68 / 612	<b>652.00</b> 789.00	<b>725.00</b> 877.30	<b>834.00</b> 1009.20	<b>906.00</b> 1096.30	<b>1015.00</b> 1228.20	<b>1160.00</b> 1403.60

Povrch hladký beton včetně protiskluzné drážky.

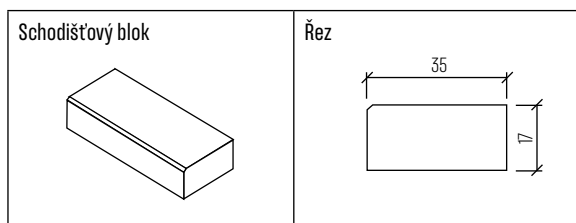

# Schodišťové prvky samonosné

Schodišťové desky samonosné					cena bez DPH / ks cena s DPH / ks			
Produkt	Paletizace [ks]	Hmotnost [kg] ks / paleta	hladký beton	oblázek 6-8, 8-10 10-16	povrch standard	povrch elegant	povrch delux	povrch extra delux
<b>150 × 30 / 6</b> (osová rozteč 120 cm)	16	62 / 992	<b>1400.00</b> 1694.00	<b>1497.00</b> 1811.40	<b>1722.00</b> 2083.70	<b>1871.00</b> 2264.00	<b>2096.00</b> 2536.20	<b>2395.00</b> 2898.00
<b>120 × 30 / 6</b> (osová rozteč 90 cm)	16	50 / 800	<b>1129.00</b> 1366.10	<b>1208.00</b> 1461.70	<b>1389.00</b> 1680.70	<b>1510.00</b> 1827.10	<b>1691.00</b> 2046.20	<b>1933.00</b> 2339.00
<b>100 × 30 / 6</b> (osová rozteč 70 cm)	20	41,5 / 830	<b>937.00</b> 1133.80	<b>1003.00</b> 1213.70	<b>1153.00</b> 1395.20	<b>1254.00</b> 1517.40	<b>1404.00</b> 1698.90	<b>1605.00</b> 1942.10
<b>240 × 35 / 8</b> (osová rozteč 210 cm)	6	155 / 930	<b>3333.00</b> 4033,00	<b>3565.00</b> 4313,70	<b>4100.00</b> 4961,00	<b>4456.00</b> 5391,80	<b>4991.00</b> 6039,20	<b>5704.00</b> 6901,90
<b>220 × 35 / 8</b> (osová rozteč 190 cm)	6	142 / 852	<b>3053.00</b> 3694,20	<b>3266.00</b> 3951,90	<b>3756.00</b> 4544,80	<b>4083.00</b> 4940,50	<b>4572.00</b> 5532,20	<b>5226.00</b> 6323,50
<b>200 × 35 / 8</b> (osová rozteč 170 cm)	6	129 / 774	<b>2774.00</b> 3356,60	<b>2967.00</b> 3590,10	<b>3412.00</b> 4128,60	<b>3709.00</b> 4487,90	<b>4154.00</b> 5026,40	<b>4747.00</b> 5743,90

Zakázková výroba i jiné rozměry.

Povrch hladký beton včetně protiskluzné drážky.

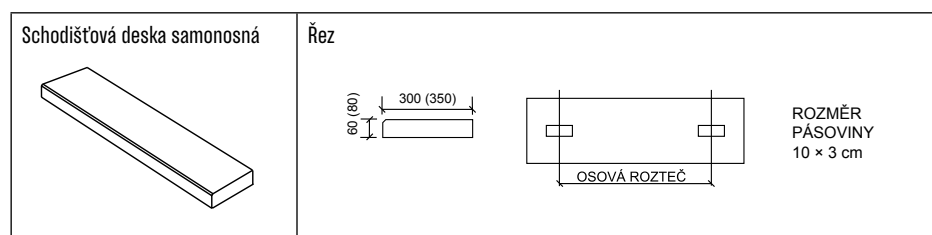



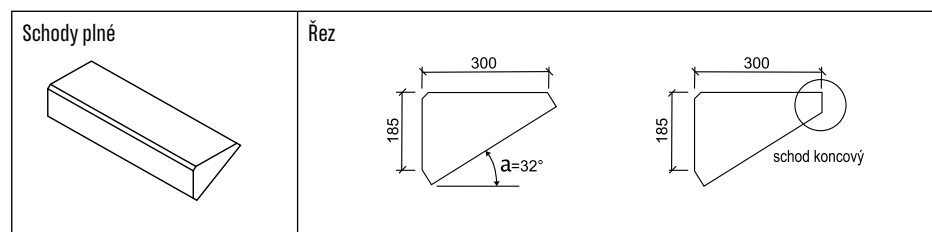









Schody plné vymývané					cena bez DPH / ks cena s DPH / ks			
Produkt	Paletizace [ks]	Hmotnost [kg] ks / paleta	oblázek 6-8, 8-10 10-16	povrch standard	povrch elegant	povrch delux	povrch extra delux	
<b>Schodišťový stupeň plný</b> 100 × 30 / 18,5	9	98 / 882	<b>1286.00</b> 1556.10	<b>1479.00</b> 1789.60	<b>1608.00</b> 1945.70	<b>1800.00</b> 2178.00	<b>2058.00</b> 2490.20	
<b>Schodišťový stupeň plný</b> 100 × 30 / 18,5 koncový	9	98 / 882	<b>1286.00</b> 1556.10	<b>1479.00</b> 1789.60	<b>1608.00</b> 1945.70	<b>1800.00</b> 2178.00	<b>2058.00</b> 2490.20	



# Květináče a truhlíky

Květináče vymývané			cena bez DPH / ks cena s DPH / ks				
Produkt	Rozměr [cm]	Hmotnost [kg]	obrázek 6-8, 8-10 10-16	povrch standard	povrch elegant	povrch delux	povrch extra delux
<b>Bella</b>	Ø 31,5 / 12	9	<b>417,00</b> 504,60	<b>480,00</b> 580,80	<b>521,00</b> 630,50	<b>584,00</b> 706,70	<b>667,00</b> 807,10
<b>Katka</b>	Ø 32 / 23	21	<b>598,00</b> 723,60	<b>688,00</b> 832,50	<b>748,00</b> 905,10	<b>837,00</b> 1012,80	<b>957,00</b> 1158,00
<b>Karla</b>	Ø 39 / 21	16,5	<b>598,00</b> 723,60	<b>688,00</b> 832,50	<b>748,00</b> 905,10	<b>837,00</b> 1012,80	<b>957,00</b> 1158,00
<b>Pegy</b>	Ø 40 / 22	21,5	<b>715,00</b> 865,20	<b>822,00</b> 994,70	<b>894,00</b> 1081,80	<b>1001,00</b> 1211,30	<b>1144,00</b> 1384,30
<b>Anta</b>	Ø 42 / 30	35	<b>715,00</b> 865,20	<b>822,00</b> 994,70	<b>894,00</b> 1081,80	<b>1001,00</b> 1211,30	<b>1144,00</b> 1384,30
<b>Sindy</b>	Ø 43 / 37	51	<b>968,00</b> 1171,30	<b>1113,00</b> 1346,80	<b>1210,00</b> 1464,10	<b>1355,00</b> 1639,60	<b>1549,00</b> 1874,30
<b>Adria</b>	Ø 50 / 18	25,5	<b>715,00</b> 865,20	<b>822,00</b> 994,70	<b>894,00</b> 1081,80	<b>1001,00</b> 1211,30	<b>1144,00</b> 1384,30
<b>Lucie</b>	Ø 59 / 20	24	<b>1025,00</b> 1240,30	<b>1179,00</b> 1426,60	<b>1281,00</b> 1550,10	<b>1435,00</b> 1736,40	<b>1640,00</b> 1984,40
<b>Eva</b>	Ø 70 / 22	44	<b>1218,00</b> 1473,80	<b>1401,00</b> 1695,30	<b>1523,00</b> 1842,90	<b>1705,00</b> 2063,10	<b>1949,00</b> 2358,30
<b>Aneta</b>	Ø 59 / 40	75	<b>1286,00</b> 1556,10	<b>1479,00</b> 1789,60	<b>1608,00</b> 1945,70	<b>1800,00</b> 2178,00	<b>2058,00</b> 2490,20
<b>Vanda</b>	Ø 65 / 33	60	<b>1286,00</b> 1556,10	<b>1479,00</b> 1789,60	<b>1608,00</b> 1945,70	<b>1800,00</b> 2178,00	<b>2058,00</b> 2490,20
<b>Bára</b>	Ø 78 / 33	205	<b>2381,00</b> 2881,10	<b>2738,00</b> 3313,00	<b>2976,00</b> 3601,00	<b>3333,00</b> 4033,00	<b>3810,00</b> 4610,10
<b>Rona</b> Obrázek jen ve vel. 8-10, 10-16 nebo větší frakce.	Ø 90 / 60	273	<b>3442,00</b> 4164,90	<b>3958,00</b> 4789,20	<b>4303,00</b> 5206,70	<b>4819,00</b> 5831,00	<b>5507,00</b> 6663,50
<b>Alex</b>	Ø 72 / 100	412	<b>4900,00</b> 5929,00	<b>5635,00</b> 6818,40	<b>6125,00</b> 7411,30	<b>6860,00</b> 8300,60	<b>7840,00</b> 9486,40

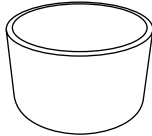
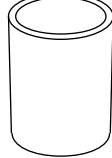
Bella 	Katka 	Karla 	Pegy 	Anta 
Sindy 	Adria 	Lucie 	Eva 	Aneta 
Vanda 	Bára 	Rona 	Alex 	

# Květináče a truhlíky

Květináče	cena bez DPH / ks cena s DPH / ks						
	Produkt	Rozměr [cm]	Hmotnost [kg]	obláček 6-8, 8-10 10-16	povrch standard	povrch elegant a trend*	povrch delux
<b>Stela</b>	47 × 47 / 20	49	<b>935,00</b> 1131,40	<b>1075,00</b> 1300,80	<b>1169,00</b> 1414,50	<b>1309,00</b> 1583,90	<b>1496,00</b> 1810,20
<b>Laura</b>	49 × 49 / 35	70	<b>1286,00</b> 1556,10	<b>1479,00</b> 1789,60	<b>1608,00</b> 1945,70	<b>1800,00</b> 2178,00	<b>2058,00</b> 2490,20
<b>Vesna</b>	50 × 50 / 35	75	<b>1286,00</b> 1556,10	<b>1479,00</b> 1789,60	<b>1608,00</b> 1945,70	<b>1800,00</b> 2178,00	<b>2058,00</b> 2490,20
<b>Sabina</b>	Ø 70 / 40	125	<b>1848,00</b> 2236,10	<b>2125,00</b> 2571,30	<b>2310,00</b> 2795,10	<b>2587,00</b> 3130,30	<b>2957,00</b> 3578,00
<b>Lolita</b> Obláček jen ve frakci 8-10, 10-16.	Ø 50 / 63	71,5	<b>1760,00</b> 2129,60	<b>2024,00</b> 2449,10	<b>2200,00</b> 2662,00	<b>2464,00</b> 2981,50	<b>2816,00</b> 3407,40
<b>Soňa</b> Obláček jen ve frakci 8-10, 10-16.	Ø 58 / 69	111	<b>1760,00</b> 2129,60	<b>2024,00</b> 2449,10	<b>2200,00</b> 2662,00	<b>2464,00</b> 2981,50	<b>2816,00</b> 3407,40
<b>Ela</b>	Ø 63 / 60	110	<b>1800,00</b> 2178,00	<b>2070,00</b> 2504,70	<b>2250,00</b> 2722,50	<b>2520,00</b> 3049,20	<b>2880,00</b> 3484,80
<b>Nora</b>	47 × 47 / 77	206	<b>2959,00</b> 3580,40	<b>3403,00</b> 4117,70	<b>3699,00</b> 4475,80	<b>4143,00</b> 5013,10	<b>4734,00</b> 5728,20
<b>Cora 1*</b>	Ø 29,5 / 53	29	<b>700,00</b> 847,00	<b>805,00</b> 974,10	<b>875,00</b> 1058,80	<b>980,00</b> 1185,80	<b>1120,00</b> 1355,20
<b>Cora 2*</b>	Ø 40 / 70	68	<b>1470,00</b> 1778,70	<b>1691,00</b> 2046,20	<b>1838,00</b> 2224,00	<b>2058,00</b> 2490,20	<b>2352,00</b> 2846,00
<b>Zara 1*</b>	27 × 27 (19 × 19) / 45	37	<b>700,00</b> 847,00	<b>805,00</b> 974,10	<b>875,00</b> 1058,80	<b>980,00</b> 1185,80	<b>1120,00</b> 1355,20
<b>Zara 2*</b>	29 × 29 (21 × 21) / 60	55	<b>1320,00</b> 1597,20	<b>1518,00</b> 1836,80	<b>1650,00</b> 1996,50	<b>1848,00</b> 2236,10	<b>2112,00</b> 2555,60
<b>Zara 3*</b>	32 × 32 (24 × 24) / 75	90	<b>1785,00</b> 2159,90	<b>2053,00</b> 2484,20	<b>2231,00</b> 2699,60	<b>2499,00</b> 3023,80	<b>2856,00</b> 3455,80
<b>Zara 4*</b>	37 × 37 (27 × 27) / 90	130	<b>2310,00</b> 2795,10	<b>2657,00</b> 3215,00	<b>2888,00</b> 3494,50	<b>3234,00</b> 3913,20	<b>3696,00</b> 4472,20

\*Povrch TREND jen u vyznačených výrobků.

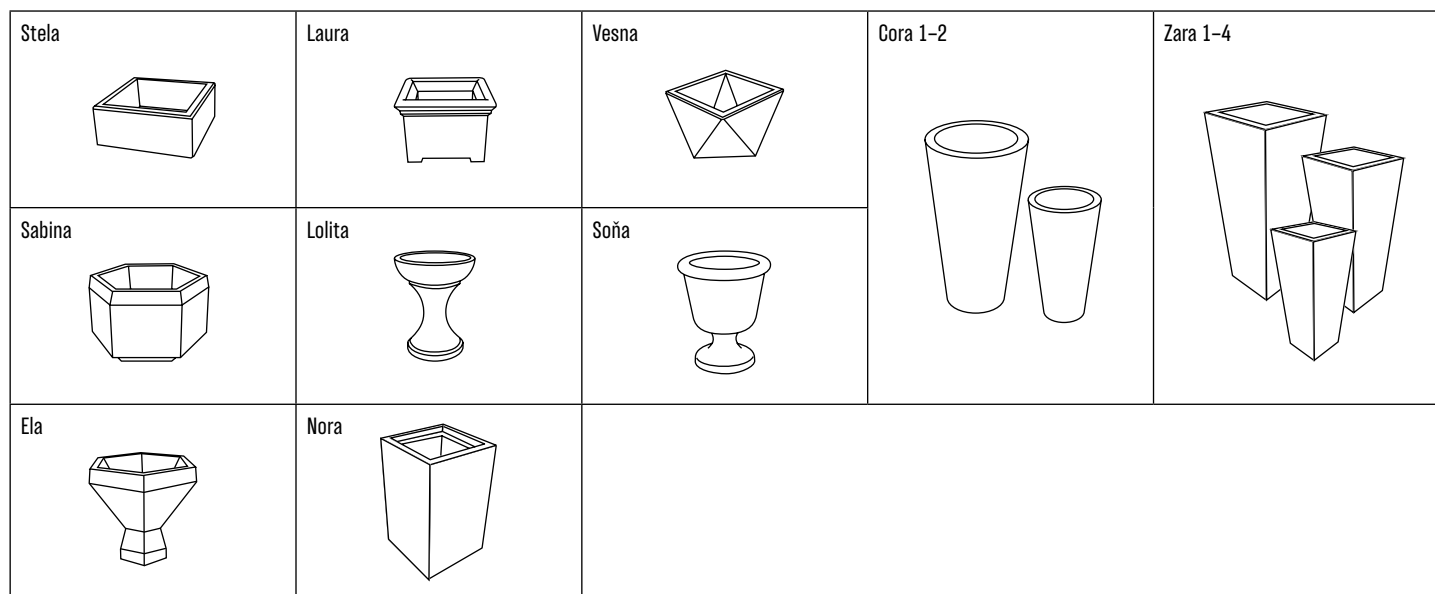



Truhlíky				cena bez DPH / ks cena s DPH / ks				
Produkt	Rozměr [cm]	Hmotnost [kg]	hladký beton	oblázek 6-8, 8-10 10-16	povrch standard	povrch elegant a trend*	povrch delux	povrch extra delux
<b>Sylva</b> Oblázek jen ve frakci 6-8, 8-10.	20 × 20 / 17,5	6		<b>396,00</b> 479,20	<b>455,00</b> 550,60	<b>495,00</b> 599,00	<b>554,00</b> 670,40	<b>634,00</b> 767,20
<b>Radka</b> Oblázek jen ve frakci 6-8, 8-10.	50 × 20 / 15	14		<b>442,00</b> 534,90	<b>508,00</b> 614,70	<b>553,00</b> 669,20	<b>619,00</b> 749,00	<b>707,00</b> 855,50
<b>Klára</b>	70 × 35 / 30	78		<b>1439,00</b> 1741,20	<b>1655,00</b> 2002,60	<b>1799,00</b> 2176,80	<b>2015,00</b> 2438,20	<b>2302,00</b> 2785,50
<b>Sonáta</b>	79 × 35 / 30	75		<b>1485,00</b> 1796,90	<b>1708,00</b> 2066,70	<b>1856,00</b> 2245,80	<b>2079,00</b> 2515,60	<b>2376,00</b> 2875,00
<b>Viktor*</b>	70 × 38 / 45	130	<b>1522,00</b> 1841,70	<b>1751,00</b> 2118,80	<b>2014,00</b> 2437,00	<b>2189,00</b> 2648,70	<b>2451,00</b> 2965,80	<b>2802,00</b> 3390,50
<b>Max*</b>	100 × 50 / 53	238	<b>2528,00</b> 3058,90	<b>2952,00</b> 3572,00	<b>3395,00</b> 4108,00	<b>3690,00</b> 4464,90	<b>4133,00</b> 5001,00	<b>4723,00</b> 5714,90
<b>Brita – truhlík</b>	101 × 43 / 45	150		<b>2228,00</b> 2695,90	<b>2562,00</b> 3100,10	<b>2785,00</b> 3369,90	<b>3119,00</b> 3774,00	<b>3565,00</b> 4313,70
<b>Brita – sestava</b>	302 × 43 / 45 (55)	344,5		<b>5088,00</b> 6156,50	<b>5851,00</b> 7079,80	<b>6360,00</b> 7695,60	<b>7123,00</b> 8618,90	<b>8141,00</b> 9850,70
<b>Erika – truhlík</b>	94 × 39 / 39	136		<b>2228,00</b> 2695,90	<b>2562,00</b> 3100,10	<b>2785,00</b> 3369,90	<b>3119,00</b> 3774,00	<b>3565,00</b> 4313,70
<b>Erika – sestava</b>	288 × 39 / 39 (54)	316		<b>5088,00</b> 6156,50	<b>5851,00</b> 7079,80	<b>6360,00</b> 7695,60	<b>7123,00</b> 8618,90	<b>8141,00</b> 9850,70
<b>Zita</b>	100 × 40 / 40	162		<b>2329,00</b> 2818,10	<b>2678,00</b> 3240,40	<b>2911,00</b> 3522,40	<b>3261,00</b> 3945,90	<b>3726,00</b> 4508,50

\*Povrch TREND jen u vyznačených výrobků.





Truhlíky – imitace kamene			cena bez DPH / ks cena s DPH / ks	
	Rozměr [cm]	Hmotnost [kg]		

**Iveta**  
žlutý barvený beton

57 × 39 / 22

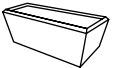
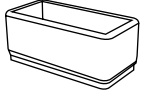
67

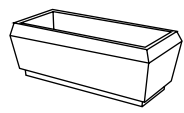
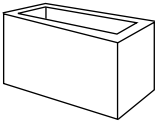
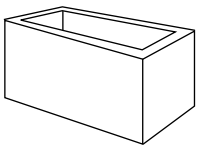
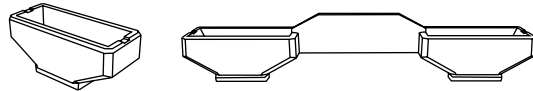
**817,00**  
988,60

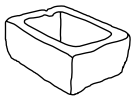
Sylva 	Radka 	Klára 	Brita – truhlík, sestava 
Sonáta 	Viktor 	Max 	Erika – truhlík, sestava 
Zita 	Iveta 		

# Zahradní nábytek

Lavice a stoly betonové				cena bez DPH / ks cena s DPH / ks			
Produkt	Rozměry [cm]	Hmotnost [kg]	obložek 6-8, 8-10 10-16	povrch standard	povrch elegant	povrch delux	povrch extra delux
<b>Sedačka Olga</b> Oblázky jen v kombinaci 6-8 a 10-16.	Ø 38 / 52	65	<b>1485,00</b> 1796,90	<b>1708,00</b> 2066,70	<b>1856,00</b> 2245,80	<b>2079,00</b> 2515,60	<b>2376,00</b> 2875,00
<b>Stůl Alan</b> Otvor na slunečník ø 5 cm, oblázky jen v kombinaci 6-8 a 10-16.	120 × 80 / 75	275	<b>5060,00</b> 6122,60	<b>5819,00</b> 7041,00	<b>6325,00</b> 7653,30	<b>7084,00</b> 8571,70	<b>8096,00</b> 9796,20
<b>Zahradní lavice Lea</b> Oblázky jen v kombinaci 6-8 a 10-16.	120 × 35 / 45	185	<b>3080,00</b> 3726,80	<b>3542,00</b> 4285,90	<b>3850,00</b> 4658,50	<b>4312,00</b> 5217,60	<b>4928,00</b> 5962,90
<b>Stůl Emil</b> Otvor na slunečník ø 6,5 cm, oblázky jen v kombinaci 6-8 a 10-16.	200 × 100 / 75	580	<b>12155,00</b> 14707,60	<b>13978,00</b> 16913,40	<b>15194,00</b> 18384,80	<b>17017,00</b> 20590,60	<b>19448,00</b> 23532,10

Sestava – lavice a stůl s dřevěnými deskami				cena bez DPH / ks cena s DPH / ks			
Produkt	Rozměry [cm]	Hmotnost [kg]	obložek 6-8, 8-10 10-16	povrch standard	povrch elegant	povrch delux	povrch extra delux
<b>Stůl Radan</b>							
Stůl – KOMPLET (desky o délce 160cm)	171 × 71 / 76	195	<b>4950,00</b> 5989,50	<b>5693,00</b> 6888,60	<b>6188,00</b> 7487,50	<b>6930,00</b> 8385,30	<b>7920,00</b> 9583,20
Betonové nohy (3 betony + kování)		172	<b>3080,00</b> 3726,80	<b>3542,00</b> 4285,90	<b>3850,00</b> 4658,50	<b>4312,00</b> 5217,60	<b>4928,00</b> 5962,90
<b>Zahradní lavička Lada</b>							
Lavička – KOMPLET (desky o délce 160cm)	171 × 65 / 87	111	<b>3950,00</b> 4779,50	<b>4543,00</b> 5497,10	<b>4938,00</b> 5975,00	<b>5530,00</b> 6691,30	<b>6320,00</b> 7647,20
Betonové nohy (2 betony + kování)		88	<b>1870,00</b> 2262,70	<b>2151,00</b> 2602,80	<b>2338,00</b> 2829,00	<b>2618,00</b> 3167,80	<b>2992,00</b> 3620,40
<b>Zahradní lavička Diana</b>							
Lavička – KOMPLET (desky o délce 160cm)	171 × 51 / 45	105	<b>3350,00</b> 4053,50	<b>3853,00</b> 4662,20	<b>4188,00</b> 5067,50	<b>4690,00</b> 5674,90	<b>5360,00</b> 6485,60
Betonové nohy (2 betony + kování)		85	<b>1650,00</b> 1996,50	<b>1898,00</b> 2296,60	<b>2063,00</b> 2496,30	<b>2310,00</b> 2795,10	<b>2640,00</b> 3194,40

Dřevěné desky i v jiných délkách na dotaz.

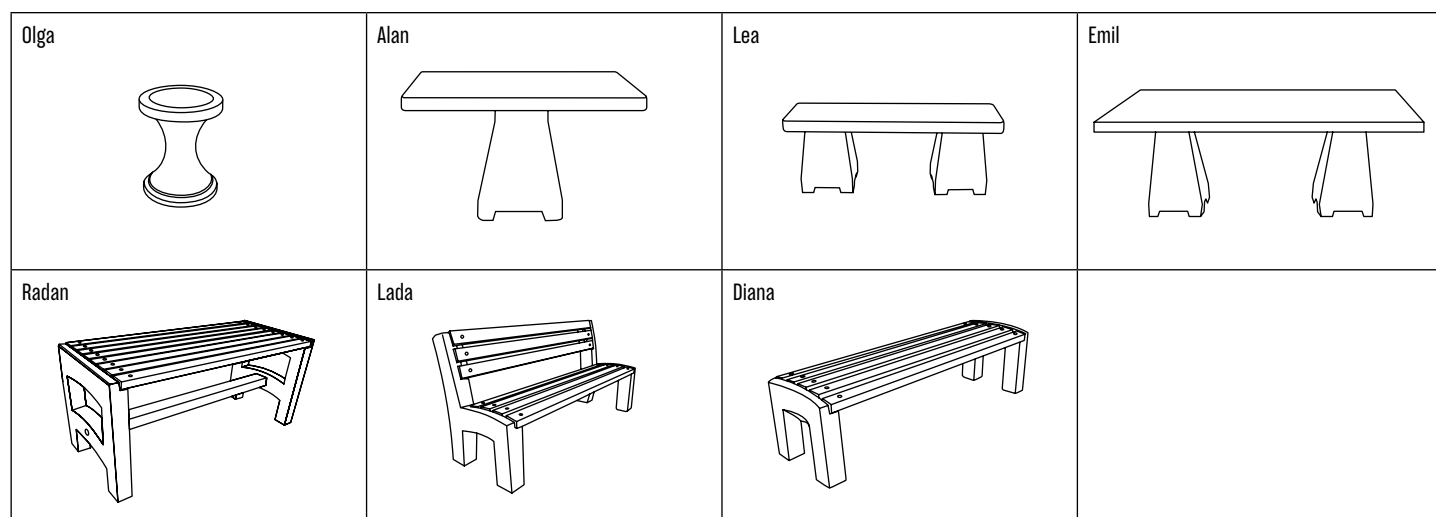

Lavice				cena bez DPH / ks cena s DPH / ks				
Produkt	Rozměry [cm]	Hmotnost [kg]	hladký beton	oblázek 6-8, 8-10 10-16	povrch standard	povrch elegant trend*	povrch delux	povrch extra delux
<b>Zahradní lavička Gita</b>								
Lavička – KOMPLET (desky o délce 160cm)	160 × 60 / 84 (40)	107		<b>3750,00</b> 4537,50	<b>4313,00</b> 5218,80	<b>4688,00</b> 5672,50	<b>5250,00</b> 6352,50	<b>6000,00</b> 7260,00
Betonové nohy (2 betony)		85		<b>1760,00</b> 2129,60	<b>2024,00</b> 2449,10	<b>2200,00</b> 2662,00	<b>2464,00</b> 2981,50	<b>2816,00</b> 3407,40
<b>Zahradní lavička Nela</b>								
Lavička – KOMPLET (desky o délce 160cm)	160 × 37 / 46	150		<b>3355,00</b> 4059,60	<b>3858,00</b> 4668,20	<b>4194,00</b> 5074,80	<b>4697,00</b> 5683,40	<b>5368,00</b> 6495,30
Betonové nohy (2 betony + kování)		135		<b>2200,00</b> 2662,00	<b>2530,00</b> 3061,30	<b>2750,00</b> 3327,50	<b>3080,00</b> 3726,80	<b>3520,00</b> 4259,20
<b>Zahradní lavička Karin*</b>								
Lavička – KOMPLET (desky o délce 160cm)	171 × 38 / 45	160	<b>3649,00</b> 4415,30	<b>3925,00</b> 4749,30	<b>4514,00</b> 5462,00	<b>4906,00</b> 5936,30	<b>5495,00</b> 6649,00	<b>6280,00</b> 7598,80
Betonové nohy (2 betony)		149	<b>2236,00</b> 2705,60	<b>2436,00</b> 2947,60	<b>2801,00</b> 3389,30	<b>3045,00</b> 3684,50	<b>3410,00</b> 4126,10	<b>3898,00</b> 4716,60

Lavička Karin vhodná do kombinace s truhlíkem Viktor.

\*Povrch TREND jen u označených výrobků.  
Dřevěné desky i v jiných délkách na dotaz.

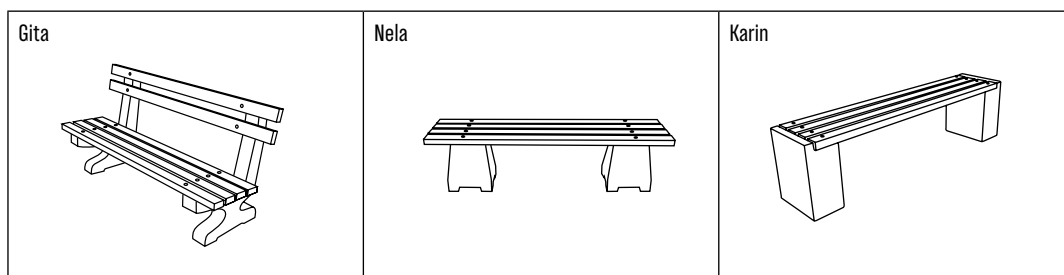

Doplňkový materiál		cena bez DPH / ks cena s DPH / ks			
Produkt		oblázek 16-32 16-125	oblázek 6-8, 8-10 10-16	barevné drtě	valouny
<b>Materiál volně ložený (Kč / kg)</b>		<b>2,50</b> 3,10	<b>4,00</b> 4,90	<b>5,00</b> 6,10	<b>6,00</b> 7,30
<b>Písek spárovací volně ložený (Kč / kg)</b>			<b>1,00</b> 1,30		

# Skruže a poklopy

Kruhové desky				cena bez DPH / ks cena s DPH / ks			
Produkt	Rozměry [cm]	Hmotnost [kg]	obláček 6-8, 8-10 10-16	povrch standard	povrch elegant	povrch delux	povrch extra delux
<b>Poklop vymývaný 80</b>	Ø 80 / 8	93	<b>1257,00</b> 1521,00	<b>1446,00</b> 1749,70	<b>1571,00</b> 1901,00	<b>1760,00</b> 2129,60	<b>2011,00</b> 2433,40
<b>Poklop vymývaný 90</b>	Ø 90 / 7	116	<b>1568,00</b> 1897,30	<b>1803,00</b> 2181,70	<b>1960,00</b> 2371,60	<b>2195,00</b> 2656,00	<b>2509,00</b> 3035,90
<b>Poklop vymývaný 100</b> Poklop půlený na skruž RONA Ø 90 / 60	Ø 100 / 8	144	<b>1947,00</b> 2355,90	<b>2239,00</b> 2709,20	<b>2434,00</b> 2945,20	<b>2726,00</b> 3298,50	<b>3115,00</b> 3769,20
<b>Poklop vymývaný 110</b>	Ø 110 / 8	174	<b>2352,00</b> 2846,00	<b>2705,00</b> 3273,10	<b>2940,00</b> 3557,40	<b>3293,00</b> 3984,60	<b>3763,00</b> 4553,30
<b>Poklop vymývaný 120</b> Poklop na skruž RONA Ø 110 / 60	Ø 120 / 8	207	<b>2798,00</b> 3385,60	<b>3218,00</b> 3893,80	<b>3498,00</b> 4232,60	<b>3917,00</b> 4739,60	<b>4477,00</b> 5417,20
<b>Poklop vymývaný 135</b> Poklop na skruž RONA Ø 130 / 60	Ø 135 / 7	240	<b>3245,00</b> 3926,50	<b>3732,00</b> 4515,80	<b>4056,00</b> 4907,80	<b>4543,00</b> 5497,10	<b>5192,00</b> 6282,40
<b>Poklop vymývaný 150</b>	Ø 150 / 7	324	<b>4380,00</b> 5299,80	<b>5037,00</b> 6094,80	<b>5475,00</b> 6624,80	<b>6132,00</b> 7419,80	<b>7008,00</b> 8479,70

Na zakázku je možné vyrobit poklop i s otvorem.  
Všechny poklopy jsou půlené se zámkem.

Skruže		cena bez DPH / ks cena s DPH / ks					
Produkt	Hmotnost [kg]	obláček 8-10, 10-16	povrch standard	povrch elegant	povrch delux	povrch extra delux	
<b>Rona Ø 90 / 60</b> (vnitřní Ø 80) bez dna	183	<b>2475,00</b> 2994,80	<b>2846,00</b> 3443,70	<b>3094,00</b> 3743,80	<b>3465,00</b> 4192,70	<b>3960,00</b> 4791,60	
<b>Rona Ø 90 / 60</b> (vnitřní Ø 80) se dnem	273	<b>3442,00</b> 4164,90	<b>3958,00</b> 4789,20	<b>4303,00</b> 5206,70	<b>4819,00</b> 5831,00	<b>5507,00</b> 6663,50	
<b>Rona Ø 110 / 60</b> (vnitřní Ø 100) bez dna	252	<b>3405,00</b> 4120,10	<b>3916,00</b> 4738,40	<b>4256,00</b> 5149,80	<b>4767,00</b> 5768,10	<b>5448,00</b> 6592,10	
<b>Rona Ø 130 / 60</b> (vnitřní Ø 120) bez dna	312	<b>4218,00</b> 5103,80	<b>4851,00</b> 5869,80	<b>5273,00</b> 6380,40	<b>5905,00</b> 7145,10	<b>6749,00</b> 8166,30	

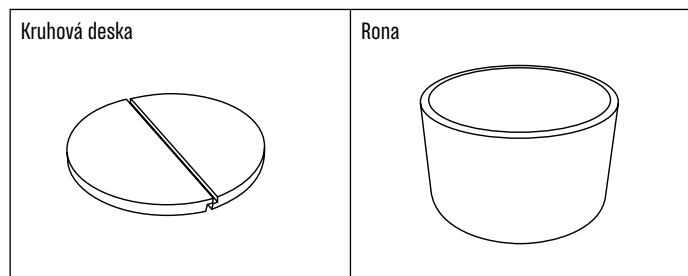

# Městský mobiliář



Zábrany				cena bez DPH / ks cena s DPH / ks				
Produkt	Rozměry [cm]	Hmotnost [kg]	hladký beton	oblázek 6-8, 8-10 10-16	povrch standard	povrch elegant trend*	povrch delux	povrch extra delux
<b>Zábrana Osmihran</b> Možnost dodání s kotevním šroubem a očkem.	Ø 40 / 85	87,5		<b>1609,00</b> 1946,90	<b>1850,00</b> 2238,50	<b>2011,00</b> 2433,40	<b>2253,00</b> 2726,20	<b>2574,00</b> 3114,60
<b>Zábrana Koule</b>	Ø 44 / 33	67		<b>968,00</b> 1171,30	<b>1113,00</b> 1346,80	<b>1210,00</b> 1464,10	<b>1355,00</b> 1639,60	<b>1549,00</b> 1874,30
<b>Zábrana Kotva*</b> Možnost dodání s kotevním šroubem a očkem.	55,5 × 30,5 / 90	140	<b>1430,00</b> 1730,30	<b>1650,00</b> 1996,50	<b>1898,00</b> 2296,60	<b>2063,00</b> 2496,30	<b>2310,00</b> 2795,10	<b>2640,00</b> 3194,40

\*Povrch TREND jen u označených výrobků.

Odpadkové koše				cena bez DPH / ks cena s DPH / ks					
Produkt	Rozměry [cm]	Hmotnost [kg]	Objem nádoby [l]	hladký beton	oblázek 6-8, 8-10 10-16	povrch standard	povrch elegant trend*	povrch delux	povrch extra delux
<b>Koš s podstavcem</b> nádoba pozinkovaná	62 × 44 / 85	119	34		<b>3703,00</b> 4480,70	<b>4258,00</b> 5152,20	<b>4629,00</b> 5601,10	<b>5184,00</b> 6272,70	<b>5925,00</b> 7169,30
<b>Koš s podstavcem</b> nádoba komaxit	62 × 44 / 85	119	34		<b>4416,00</b> 5343,40	<b>5078,00</b> 6144,40	<b>5520,00</b> 6679,20	<b>6182,00</b> 7480,30	<b>7066,00</b> 8549,90
<b>Koš Hugo</b>	47 × 47 / 77	210	42		<b>3623,00</b> 4383,90	<b>4166,00</b> 5040,90	<b>4529,00</b> 5480,10	<b>5072,00</b> 6137,20	<b>5797,00</b> 7014,40
<b>Koš Hugo</b> se stříškou	47 × 47 / 97	230	42		<b>4773,00</b> 5775,40	<b>5489,00</b> 6641,70	<b>5966,00</b> 7218,90	<b>6682,00</b> 8085,30	<b>7637,00</b> 9240,80
<b>Koš Hugo</b> se stříškou a popelníkem	47 × 47 / 97	230	42		<b>5302,00</b> 6415,50	<b>6097,00</b> 7377,40	<b>6628,00</b> 8019,90	<b>7423,00</b> 8981,90	<b>8483,00</b> 10264,50
<b>Koš Igor*</b> nádoba pozinkovaná	38,5 × 38,5 / 90	114	40	<b>2415,00</b> 2922,20	<b>2645,00</b> 3200,50	<b>3042,00</b> 3680,90	<b>3306,00</b> 4000,30	<b>3703,00</b> 4480,70	<b>4232,00</b> 5120,80
<b>Koš Igor*</b> nádoba komaxit	38,5 × 38,5 / 90	114	40	<b>3128,00</b> 3784,90	<b>3358,00</b> 4063,20	<b>3862,00</b> 4673,10	<b>4198,00</b> 5079,60	<b>4701,00</b> 5688,30	<b>5373,00</b> 6501,40

\*Povrch TREND jen u označených výrobků.

Stojan na kolo				cena bez DPH / ks cena s DPH / ks				
Produkt	Rozměry [cm]	Hmotnost [kg]		oblázek 6-8, 8-10 10-16	povrch standard	povrch elegant trend	povrch delux	povrch extra delux
<b>Stojan na kolo</b>	75 × 37 / 20	45		<b>656,00</b> 793,80	<b>754,00</b> 912,40	<b>820,00</b> 992,20	<b>918,00</b> 1110,80	<b>1050,00</b> 1270,50

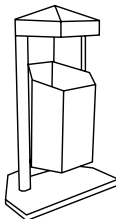
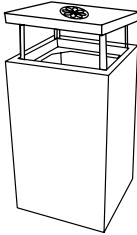
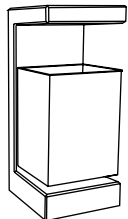
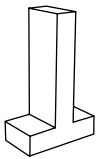
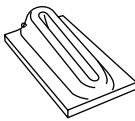
Osmihran 	Koule 	Koš s podstavcem 	Koš Hugo 	Koš Igor 
Kotva 	Stojan na kolo 			

# Zahradní doplňky

Zahradní osvětlení				cena bez DPH / ks cena s DPH / ks			
Produkt	Rozměry [cm]	Hmotnost [kg]	oblázek 6-8, 8-10	povrch standard	povrch elegant	povrch delux	povrch extra delux
<b>Světlo Alda 1</b>	20 × 19 / 51	13	<b>1029,00</b> 1245,10	<b>1183,00</b> 1431,50	<b>1286,00</b> 1556,10	<b>1441,00</b> 1743,70	<b>1646,00</b> 1991,70
<b>Světlo Alda 2</b>	20 × 19 / 72	22	<b>1210,00</b> 1464,10	<b>1392,00</b> 1684,40	<b>1513,00</b> 1830,80	<b>1694,00</b> 2049,80	<b>1936,00</b> 2342,60
<b>Světlo Alda 3</b>	20 × 19 / 93	31	<b>1392,00</b> 1684,40	<b>1601,00</b> 1937,30	<b>1740,00</b> 2105,40	<b>1949,00</b> 2358,30	<b>2227,00</b> 2694,70

Kryt světla: plastová koule kouřová (max. 75W).

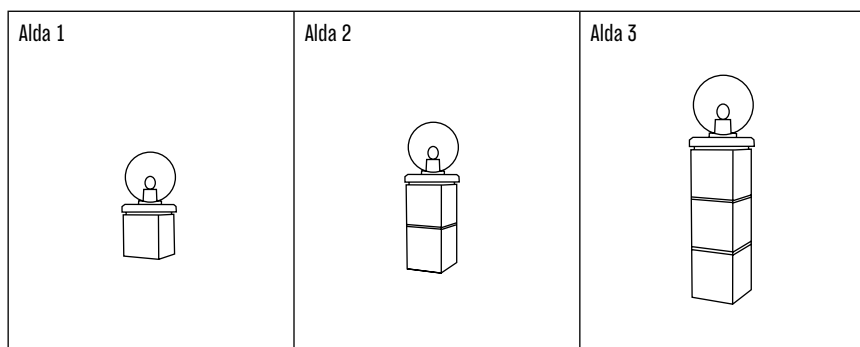

Kašna				cena bez DPH / ks cena s DPH / ks			
Produkt	Rozměry [cm]	Hmotnost [kg]	oblázek 6-8, 8-10 10-16	povrch standard	povrch elegant	povrch delux	povrch extra delux
<b>Kašna – komplet</b>	100 × 47 / 96	238	<b>3795,00</b> 4592,00	<b>4364,00</b> 5280,50	<b>4744,00</b> 5740,30	<b>5313,00</b> 6428,80	<b>6072,00</b> 7347,20
<b>Kašna – samostatná deska</b>	35 × 14 / 96	76	<b>1243,00</b> 1504,10	<b>1429,00</b> 1729,10	<b>1554,00</b> 1880,40	<b>1740,00</b> 2105,40	<b>1989,00</b> 2406,70
<b>Kašna – samostatná nádoba</b>	100 × 40 / 40	162	<b>2552,00</b> 3088,00	<b>2935,00</b> 3551,40	<b>3190,00</b> 3859,90	<b>3573,00</b> 4323,40	<b>4083,00</b> 4940,50

Včetně zahradního kohoutu a zátky.

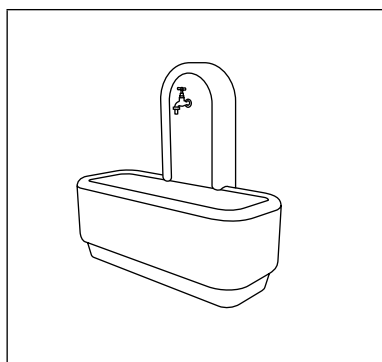

Umyvadlo					cena bez DPH / ks cena s DPH / ks			
Produkt	Rozměry [cm]	Hmotnost [kg]	oblázek 6-8, 8-10 10-16	povrch standard	povrch elegant	povrch delux	povrch extra delux	
<b>Umyvadlo – komplet</b>	47 × 55,5 / 120	195	<b>3968,00</b> 4801,30	<b>4563,00</b> 5521,30	<b>4960,00</b> 6001,60	<b>5555,00</b> 6721,60	<b>6349,00</b> 7682,30	
<b>Umyvadlo – jen nádoba</b>	47 × 47 / 20	49	<b>1125,00</b> 1361,30	<b>1294,00</b> 1565,80	<b>1406,00</b> 1701,30	<b>1575,00</b> 1905,80	<b>1800,00</b> 2178,00	
<b>Umyvadlo – jen deska</b>	25 × 12 / 120	62	<b>1574,00</b> 1904,60	<b>1810,00</b> 2190,10	<b>1968,00</b> 2381,30	<b>2204,00</b> 2666,90	<b>2518,00</b> 3046,80	
<b>Umyvadlo – jen 1 tvárnice</b>	40 × 40 / 20	28	<b>423,00</b> 511,90	<b>486,00</b> 588,10	<b>529,00</b> 640,10	<b>592,00</b> 716,40	<b>677,00</b> 819,20	

Včetně zahradního kohoutu a odpadu.

Mlýnské kolo			cena bez DPH / ks cena s DPH / ks	
Produkt	Rozměry [cm]	Hmotnost [kg]	imitace přírodního kamene	
<b>Mlýnské kolo</b>	Ø 80 / 12	130	<b>1164,00</b> 1408,50	

Gril a krbový stolek					cena bez DPH / ks cena s DPH / ks			
Produkt	Rozměry [cm]	Hmotnost [kg]	oblázek 6-8, 8-10 10-16	povrch standard	povrch elegant	povrch delux	povrch extra delux	
<b>Gril zahradní</b>	120 × 70 / 104	488	<b>6500,00</b> 7865,00	<b>7475,00</b> 9044,80	<b>8125,00</b> 9831,30	<b>9100,00</b> 11011,00	<b>10400,00</b> 12584,00	
<b>Krbový stolek</b>	78 × 50 / 52	165	<b>1565,00</b> 1893,70	<b>1800,00</b> 2178,00	<b>1956,00</b> 2366,80	<b>2191,00</b> 2651,20	<b>2504,00</b> 3029,90	

V ceně kompletu grilovací rošt a rošt pro ohniště.

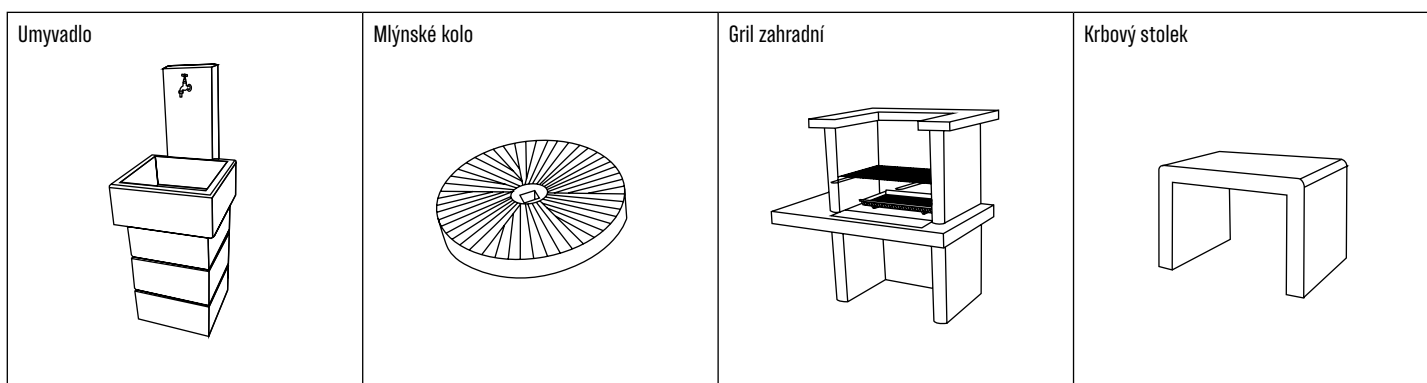

# Plotové tvárnice a systémy

Plotové tvárnice vymývané					cena bez DPH / ks cena s DPH / ks			
Produkt	Spotřeba ks / m <sup>2</sup>	Paletizace [ks]	Hmotnost [kg] ks / paleta	obláček 6-8, 8-10 10-16	povrch standard	povrch elegant	povrch delux	povrch extra delux
<b>Tvárnice – jednostranná</b> 40 × 20 / 20	12,5	60	20 / 1200	<b>115,00</b> 139,20	<b>132,00</b> 159,80	<b>144,00</b> 174,30	<b>161,00</b> 194,90	<b>184,00</b> 222,70
<b>Tvárnice – průběžná</b> 40 × 20 / 20	12,5	60	20 / 1200	<b>123,00</b> 148,90	<b>141,00</b> 170,70	<b>154,00</b> 186,40	<b>172,00</b> 208,20	<b>197,00</b> 238,40
<b>Tvárnice – sloupková</b> 40 × 20 / 20	12,5	60	20 / 1200	<b>136,00</b> 164,60	<b>156,00</b> 188,80	<b>170,00</b> 205,70	<b>190,00</b> 229,90	<b>218,00</b> 263,80
<b>Tvárnice – půlka</b> 20 × 20 / 20	25	120	10 / 1200	<b>108,00</b> 130,70	<b>124,00</b> 150,10	<b>135,00</b> 163,40	<b>151,00</b> 182,80	<b>173,00</b> 209,40
<b>Tvárnice – sloupová</b> 30 × 30 / 20	16,7	60	20 / 1200	<b>273,00</b> 330,40	<b>314,00</b> 380,00	<b>341,00</b> 412,70	<b>382,00</b> 462,30	<b>437,00</b> 528,80
<b>Tvárnice – pilířová</b> 50 × 50 / 42 – vytváří betonovu spáru 1 cm		4	78 / 312	<b>630,00</b> 762,30	<b>725,00</b> 877,30	<b>788,00</b> 953,50	<b>882,00</b> 1067,30	<b>1008,00</b> 1219,70
<b>Tvárnice – pilířová</b> 60 × 60 / 42 – vytváří betonovu spáru 1 cm		4	100 / 400	<b>883,00</b> 1068,50	<b>1015,00</b> 1228,20	<b>1104,00</b> 1335,90	<b>1236,00</b> 1495,60	<b>1413,00</b> 1709,80

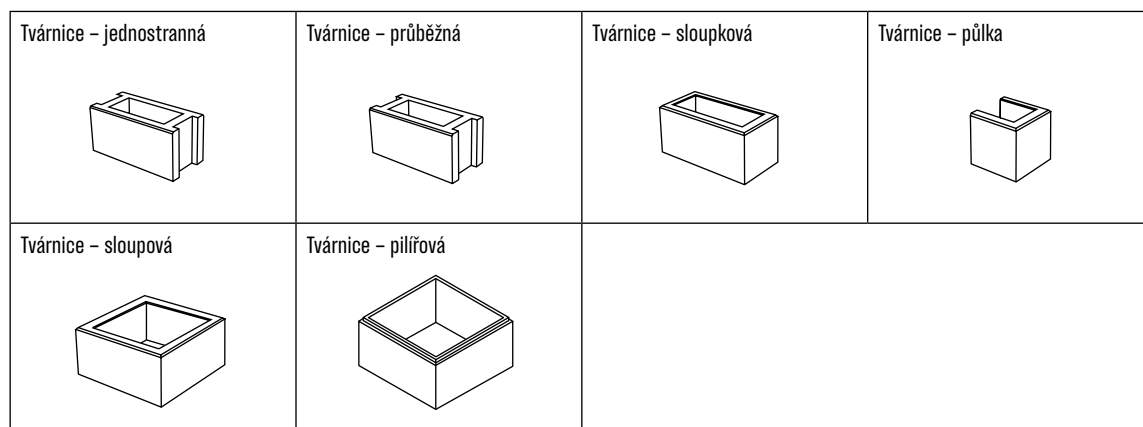

Plotové tvárnice hladké				cena bez DPH / ks cena s DPH / ks	
Produkt	Spotřeba ks / m <sup>2</sup>	Paletizace [ks]	Hmotnost [kg] ks / paleta	šedá	červená, písková, hnědá
<b>Tvárnice 40 × 20 / 16</b>	15,6	72 (48+24)	13,7 / 987	<b>43,00</b> 52,10	<b>55,00</b> 66,60
Tvárnice jsou paletované v poměru 2 : 1 (běžná : dělitelná)					
<b>Tvárnice 60 × 20 / 16</b>	10,42	48	18 / 864	<b>59,00</b> 71,40	

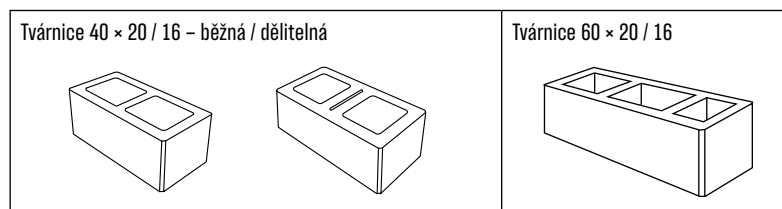



Plotové tvárnice štípané					cena bez DPH / ks cena s DPH / ks	
Produkt	Rozměry [cm]	Spotřeba ks / m <sup>2</sup>	Paletizace ks	Hmotnost [kg] ks / paleta	šedá	červená, písková, hnědá
<b>Tvárnice štípané – výška 16 cm</b>						
Tvárnice – jednostranná	40 × 20 / 16	15,6	50	16 / 800	<b>51,00</b> 61,80	<b>69,00</b> 83,50
Tvárnice – oboustranná	40 × 20 / 16	15,6	50	17 / 850	<b>67,00</b> 81,10	<b>90,00</b> 108,90
<b>Stříška štípaná</b>	20 × 30 / 7		100	6 / 600	<b>60,00</b> 72,60	<b>79,00</b> 95,60

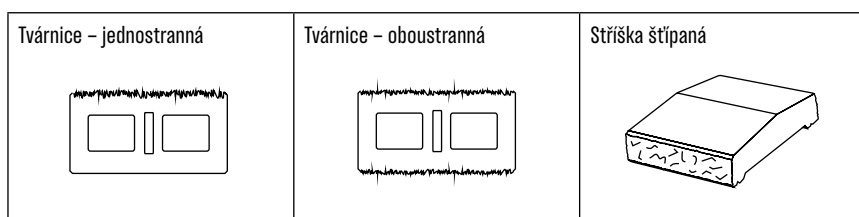

Podhrabové desky vymývané				cena bez DPH / ks cena s DPH / ks			
Produkt	Rozměry [cm]	Hmotnost [kg]	oblázek 6-8, 8-10 10-16	povrch standard	povrch elegant	povrch delux	povrch extra delux
<b>Podhrabová deska 20</b> Oboustranné	245 × 5 / 20	56	<b>1160,00</b> 1403,60	<b>1334,00</b> 1614,20	<b>1450,00</b> 1754,50	<b>1624,00</b> 1965,10	<b>1856,00</b> 2245,80
<b>Podhrabová deska 30</b> Oboustranné	245 × 5 / 30	85	<b>1350,00</b> 1633,50	<b>1553,00</b> 1879,20	<b>1688,00</b> 2042,50	<b>1890,00</b> 2286,90	<b>2160,00</b> 2613,60

Zakázková výroba do max. délky 260cm.

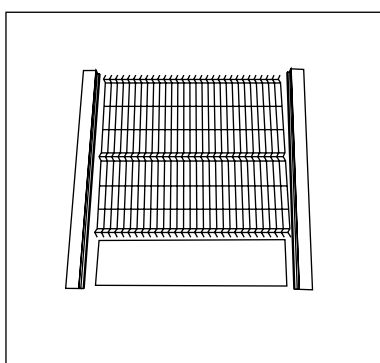

# Plotové tvárnice a systémy

Stříšky ploché – hladké					cena bez DPH / ks cena s DPH / ks
Produkt	Rozměr [mm] š / d / v	Určeno pro zed' šířky [cm]	Paletizace [ks]	Hmotnost [kg] ks / paleta	šedá
<b>Stříška průběžná</b>					
<b>27 / 100</b>	270 / 1000 / 40	20	20	25 / 500	<b>320.00</b> 387.20
<b>33 / 100</b>	330 / 1000 / 40	25	20	30 / 600	<b>436.00</b> 527.60
<b>37 / 100</b>	370 / 1000 / 40	30	15	34 / 510	<b>491.00</b> 594.20
<b>42 / 100</b>	420 / 1000 / 40	35	15	39 / 585	<b>516.00</b> 624.40
<b>57 / 100</b>	570 / 1000 / 50	50	10	66 / 660	<b>910.00</b> 1101.10
<b>Stříška sloupková</b>					
<b>27 × 47</b>	270 / 470 / 40	20 × 40	12		<b>240.00</b> 290.40
<b>37 × 37</b>	370 / 370 / 40	30 × 30	13		<b>282.00</b> 341.30
<b>47 × 47</b>	470 / 470 / 40	40 × 40	20		<b>390.00</b> 471.90
<b>57 × 57</b>	570 / 570 / 40	50 × 50	30		<b>496.00</b> 600.20
<b>67 × 67</b>	670 / 670 / 40	60 × 60	42		<b>664.00</b> 803.50



Stříšky jsou opatřeny okapovou drážkou!

## Stříšky ploché – hladké

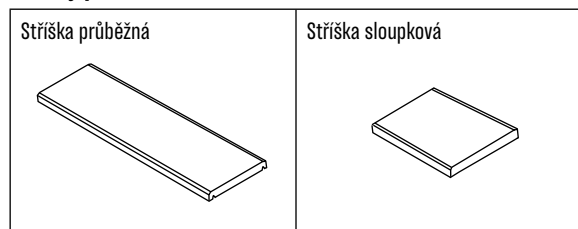

## Stříšky sedlové – hladké

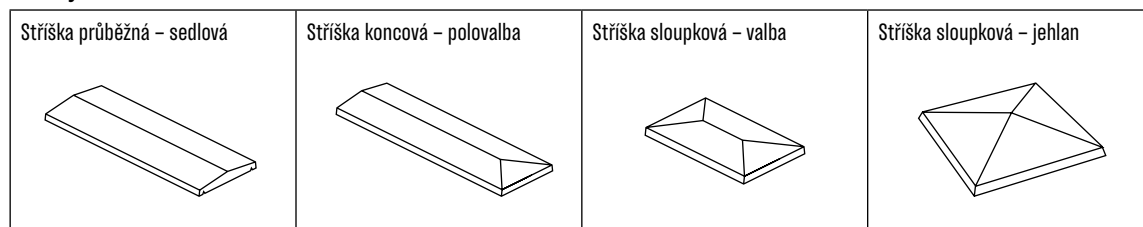

Stříšky sedlové – hladké					cena bez DPH / ks cena s DPH / ks
Produkt	Rozměr [mm] š / d / v	Určeno pro zed' šířky [cm]	Paletizace [ks]	Hmotnost [kg] ks / paleta	šedá
<b>Stříška průběžná – sedlová</b>					
<b>18 / 100</b>	180 / 1000 / 45	10	30	20 / 600	<b>261,00</b> 315,90
<b>23 / 110</b>	230 / 1100 / 65	15	25	28 / 700	<b>329,00</b> 398,10
<b>31 / 100</b>	310 / 1000 / 70	20	20	44 / 880	<b>369,00</b> 446,50
<b>37 / 100</b>	370 / 1000 / 80	30	15	53 / 795	<b>460,00</b> 556,60
<b>51 / 100</b>	510 / 1000 / 75	40	10	78 / 780	<b>645,00</b> 780,50
<b>58 / 80</b>	580 / 800 / 85	47	10	65 / 680	<b>551,00</b> 666,80
<b>67 / 50</b>	670 / 500 / 90	56	10	50 / 500	<b>475,00</b> 574,80
<b>Stříška koncová – polovalba</b>					
<b>31 / 100</b>	310 / 1000 / 70	20	20	44 / 880	<b>369,00</b> 446,50
<b>71 / 107</b>	710 / 1070 / 70	60	5	101 / 505	<b>1075,00</b> 1300,80
<b>Stříška sloupková – valba</b>					
<b>31 / 50</b>	310 / 500 / 70	20 × 40	20	21 / 420	<b>240,00</b> 290,40
<b>Stříška sloupková – jehlan</b>					
<b>31 × 31</b>	310 / 310 / 50	20 × 20	34	8 / 272	<b>174,00</b> 210,60
<b>40 × 40</b>	400 / 400 / 100	30 × 30	20	22,5 / 450	<b>266,00</b> 321,90
<b>50 × 50</b>	500 / 500 / 110	40 × 40	10	40 / 400	<b>395,00</b> 478,00
<b>60 × 60</b>	600 / 600 / 110	50 × 50	4	50 / 200	<b>523,00</b> 632,90
<b>42 × 55</b>	420 / 550 / 75	32 × 45	4	29 / 116	<b>306,00</b> 370,30
<b>55 × 65</b>	550 / 650 / 80	45 × 55	2	44 / 88	<b>389,00</b> 470,70
<b>60 × 77</b>	600 / 770 / 80	50 × 67	2	60 / 120	<b>571,00</b> 691,00

Stříšky jsou opatřeny okapovou drážkou!

# Plotové tvárnice a systémy

Produkt	Rozměr [mm] š / d / v	Určeno pro zed' šířky [cm]	Paletizace [ks]	Hmotnost [kg] ks / paleta	obláček 6-8, 8-10 10-16	cena bez DPH / ks cena s DPH / ks			
						povrch standard	povrch elegant	povrch delux	povrch extra delux
<b>Stříška průběžná</b>									
<b>27 / 100</b>	270 / 1000 / 40	20	30	25 / 750	<b>332.00</b> 401.80	<b>382.00</b> 462.30	<b>415.00</b> 502.20	<b>465.00</b> 562.70	<b>531.00</b> 642.60
<b>33 / 100</b>	330 / 1000 / 40	25	20	30 / 600	<b>485.00</b> 586.90	<b>558.00</b> 675.20	<b>606.00</b> 733.30	<b>679.00</b> 821.60	<b>776.00</b> 939.00
<b>37 / 100</b>	370 / 1000 / 40	30	15	34 / 510	<b>514.00</b> 622.00	<b>591.00</b> 715.20	<b>643.00</b> 778.10	<b>720.00</b> 871.20	<b>822.00</b> 994.70
<b>42 / 100</b>	420 / 1000 / 40	35	15	39 / 585	<b>541.00</b> 654.70	<b>622.00</b> 752.70	<b>676.00</b> 818.00	<b>757.00</b> 916.00	<b>866.00</b> 1047.90
<b>57 / 100</b>	570 / 1000 / 50	50	10	66 / 660	<b>915.00</b> 1107.20	<b>1052.00</b> 1273.00	<b>1144.00</b> 1384.30	<b>1281.00</b> 1550.10	<b>1464.00</b> 1771.50
<b>Stříška sloupková</b>									
<b>27 × 47</b>	270 / 470 / 40	20 × 40		12 / -	<b>253.00</b> 306.20	<b>291.00</b> 352.20	<b>316.00</b> 382.40	<b>354.00</b> 428.40	<b>405.00</b> 490.10
<b>37 × 37</b>	370 / 370 / 40	30 × 30		13 / -	<b>300.00</b> 363.00	<b>345.00</b> 417.50	<b>375.00</b> 453.80	<b>420.00</b> 508.20	<b>480.00</b> 580.80
<b>47 × 47</b>	470 / 470 / 40	40 × 40		20 / -	<b>459.00</b> 555.40	<b>528.00</b> 638.90	<b>574.00</b> 694.60	<b>643.00</b> 778.10	<b>734.00</b> 888.20
<b>57 × 57</b>	570 / 570 / 40	50 × 50		30 / -	<b>634.00</b> 767.20	<b>729.00</b> 882.10	<b>793.00</b> 959.60	<b>888.00</b> 1074.50	<b>1014.00</b> 1227.00
<b>67 × 67</b>	670 / 670 / 40	60 × 60		42 / -	<b>887.00</b> 1073.30	<b>1020.00</b> 1234.20	<b>1109.00</b> 1341.90	<b>1242.00</b> 1502.90	<b>1419.00</b> 1717.00

Stříšky jsou opatřeny okapovou drážkou!

## Stříšky ploché – vymývané

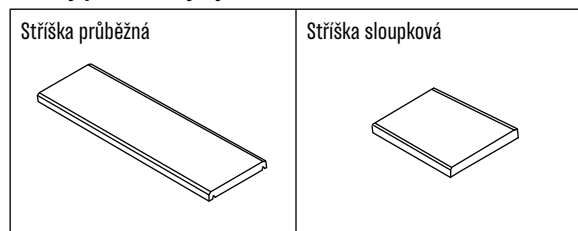

## Stříšky sedlové – vymývané

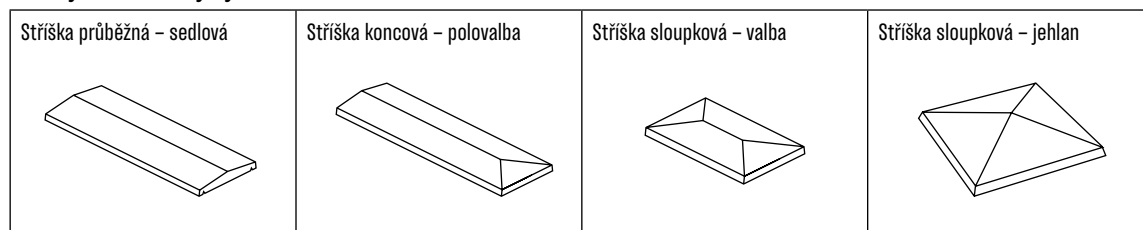

Stříšky sedlové – vymývané						cena bez DPH / ks cena s DPH / ks			
Produkt	Rozměr [mm] š / d / v	Určeno pro zed' šířky (cm)	Paletizace [ks]	Hmotnost [kg] ks / paleta	obláček 6-8, 8-10 10-16	povrch standard	povrch elegant	povrch delux	povrch extra delux
<b>Stříška průběžná – sedlová</b>									
<b>18 / 100</b>	180 / 1000 / 45	10	30	20 / 600	<b>336,00</b> 406,60	<b>386,00</b> 467,10	<b>420,00</b> 508,20	<b>470,00</b> 568,70	<b>538,00</b> 651,00
<b>23 / 100</b>	230 / 1000 / 65	15	25	28 / 700	<b>361,00</b> 436,90	<b>415,00</b> 502,20	<b>451,00</b> 545,80	<b>505,00</b> 611,10	<b>578,00</b> 699,40
<b>31 / 100</b>	310 / 1000 / 70	20	20	44 / 880	<b>452,00</b> 547,00	<b>520,00</b> 629,20	<b>565,00</b> 683,70	<b>633,00</b> 766,00	<b>723,00</b> 874,90
<b>37 / 100</b>	370 / 1000 / 80	30	15	53 / 795	<b>503,00</b> 608,70	<b>578,00</b> 699,40	<b>629,00</b> 761,10	<b>704,00</b> 851,90	<b>805,00</b> 974,10
<b>51 / 100</b>	510 / 1000 / 75	40	10	78 / 780	<b>740,00</b> 895,40	<b>851,00</b> 1029,80	<b>925,00</b> 1119,30	<b>1036,00</b> 1253,60	<b>1184,00</b> 1432,70
<b>58 / 80</b>	580 / 800 / 85	47	10	65 / 680	<b>627,00</b> 758,70	<b>721,00</b> 872,50	<b>784,00</b> 948,70	<b>878,00</b> 1062,40	<b>1003,00</b> 1213,70
<b>67 / 50</b>	670 / 500 / 90	56	10	50 / 500	<b>544,00</b> 658,30	<b>626,00</b> 757,50	<b>680,00</b> 822,80	<b>762,00</b> 922,10	<b>870,00</b> 1052,70
<b>Stříška koncová – polovalba</b>									
<b>31 / 100</b>	310 / 1000 / 70	20	20	44 / 880	<b>452,00</b> 547,00	<b>520,00</b> 629,20	<b>565,00</b> 683,70	<b>633,00</b> 766,00	<b>723,00</b> 874,90
<b>71 / 107</b>	710 / 1070 / 70	60	5	101 / 505	<b>1277,00</b> 1545,20	<b>1469,00</b> 1777,50	<b>1596,00</b> 1931,20	<b>1788,00</b> 2163,50	<b>2043,00</b> 2472,10
<b>Stříška sloupková – valba</b>									
<b>31 / 50</b>	310 / 500 / 70	20 × 40	20	21 / 420	<b>260,00</b> 314,60	<b>299,00</b> 361,80	<b>325,00</b> 393,30	<b>364,00</b> 440,50	<b>416,00</b> 503,40
<b>Stříška sloupková – jehlan</b>									
<b>31 × 31</b>	310 / 310 / 50	20 × 20	34	8 / 272	<b>200,00</b> 242,00	<b>230,00</b> 278,30	<b>250,00</b> 302,50	<b>280,00</b> 338,80	<b>320,00</b> 387,20
<b>40 × 40</b>	400 / 400 / 100	30 × 30	20	22,5 / 450	<b>288,00</b> 348,50	<b>331,00</b> 400,60	<b>360,00</b> 435,60	<b>403,00</b> 487,70	<b>461,00</b> 557,90
<b>50 × 50</b>	500 / 500 / 110	40 × 40	10	40 / 400	<b>474,00</b> 573,60	<b>545,00</b> 659,50	<b>593,00</b> 717,60	<b>664,00</b> 803,50	<b>758,00</b> 917,20
<b>60 × 60</b>	600 / 600 / 110	50 × 50	4	50 / 200	<b>578,00</b> 699,40	<b>665,00</b> 804,70	<b>723,00</b> 874,90	<b>809,00</b> 978,90	<b>925,00</b> 1119,30
<b>42 × 55</b>	420 / 550 / 75	32 × 45	4	29 / 116	<b>393,00</b> 475,60	<b>452,00</b> 547,00	<b>491,00</b> 594,20	<b>550,00</b> 665,50	<b>629,00</b> 761,10
<b>55 × 65</b>	550 / 650 / 80	45 × 55	2	44 / 88	<b>455,00</b> 550,60	<b>523,00</b> 632,90	<b>569,00</b> 688,50	<b>637,00</b> 770,80	<b>728,00</b> 880,90
<b>60 × 77</b>	600 / 770 / 80	50 × 67	2	60 / 120	<b>595,00</b> 720,00	<b>684,00</b> 827,70	<b>744,00</b> 900,30	<b>833,00</b> 1008,00	<b>952,00</b> 1152,00

Stříšky jsou opatřeny okapovou drážkou!

# Ztracené bednění a svahové tvárnice

Ztracené bednění				cena bez DPH / ks cena s DPH / ks
Produkt	Spotřeba ks / m <sup>2</sup>	Paletizace [ks]	Hmotnost [kg] ks / paleta	šedá
<b>Ztracené bednění – se zámkem výška 20 cm</b>				
<b>ZTB 50 × 15 / 20</b>	10	80	13 / 1040	<b>32.00</b> 38.80
<b>ZTB 50 × 20 / 20</b>	10	60	15 / 900	<b>35.00</b> 42.40
<b>ZTB 50 × 30 / 20</b>	10	40	20 / 800	<b>41.00</b> 49.70
<b>ZTB 50 × 40 / 20</b>	10	30	25 / 750	<b>50.00</b> 60.50







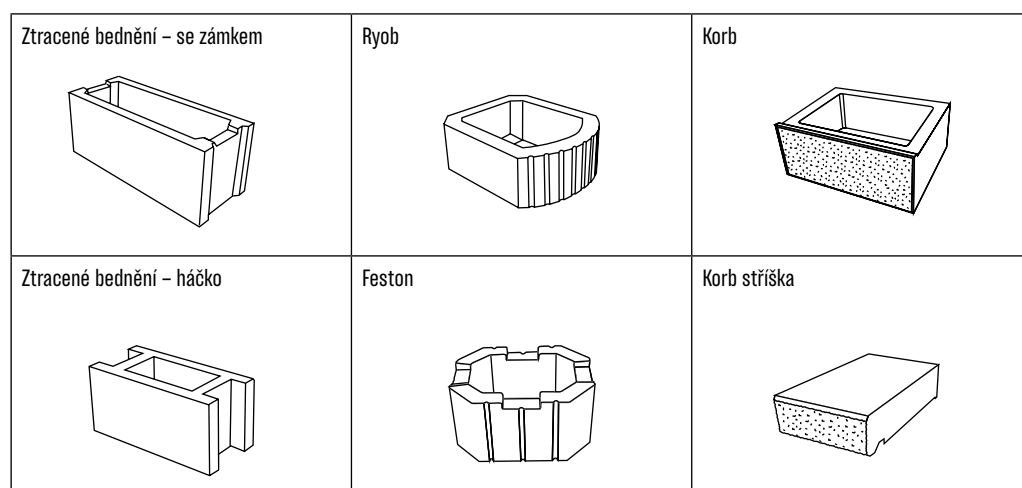







Ztracené bednění – háčko				cena bez DPH / ks cena s DPH / ks
Produkt	Spotřeba ks / m <sup>2</sup>	Paletizace [ks]	Hmotnost [kg] ks / paleta	šedá
<b>ZTB 50 × 25 / 20</b>	10	40	20 / 800	<b>37.00</b> 44.80

Svahové tvárnice					cena bez DPH / ks cena s DPH / ks
Produkt	Skladebná výška [cm]	Paletizace [ks]	Hmotnost [kg] ks / paleta	šedá	červená, písková, hnědá
<b>Ryob</b> 30 × 33 / 13	13	72	13 / 936	<b>41,00</b> 49,70	<b>55,00</b> 66,60
<b>Feston</b> 40 × 30 / 20	18	40	20,5 / 820	<b>69,00</b> 83,50	<b>91,00</b> 110,20

Svahové tvárnice štípané					cena bez DPH / ks cena s DPH / ks
Produkt	Paletizace [ks]	Hmotnost [kg] ks / paleta	šedá	červená, písková, hnědá	
<b>Korb</b> 40 × 30 / 16	40	16 / 640	<b>71,00</b> 86,00	<b>95,00</b> 115,00	
<b>Korb stříška</b> 20 × 35 / 8	56	11 / 616	<b>61,00</b> 73,90	<b>79,00</b> 95,60	



# Palisády

Palisády							cena bez DPH / ks cena s DPH / ks	
Produkt		Rozměry [cm]	Spotřeba ks / bm	Paletizace [ks]	Hmotnost [kg] ks / paleta	šedá	červená, písková, hnědá	
<b>Palisáda Delta</b>								
Delta 30	 ZBOŽÍ JE DOČASNĚ NEDOSTUPNÉ	13,5 × 11 / 30	7,5	110	9 / 990	45,00 54,50	59,00 71,40	
Delta 40		13,5 × 11 / 40	7,5	90	12 / 1080	60,00 72,60	78,00 94,40	
Delta 50		13,5 × 11 / 50	7,5	90	15 / 1350	80,00 96,80	104,00 125,90	
Delta 60		13,5 × 11 / 60	7,5	65	18 / 1170	96,00 116,20	125,00 151,30	
Delta 80		13,5 × 11 / 80	7,5	45	24 / 1080	127,00 153,70	165,00 199,70	
Delta 100		13,5 × 11 / 100	7,5	45	30 / 1350	164,00 198,50	213,00 257,80	
Delta 120		13,5 × 11 / 120	7,5	30	36 / 1080	191,00 231,20	248,00 300,10	
<b>Palisáda Ronda</b>								
Ronda 30	 ZBOŽÍ JE DOČASNĚ NEDOSTUPNÉ	Ø 11,5 / 30	10	66	5,5 / 388	36,00 43,60	47,00 56,90	
Ronda 40		Ø 11,5 / 40	10	66	7,5 / 520	47,00 56,90	65,00 78,70	
Ronda 60		Ø 11,5 / 60	10	66	11,5 / 784	80,00 96,80	110,00 133,10	
<b>Palisáda Kvadra</b>								
Kvadra 40	 ZBOŽÍ JE DOČASNĚ NEDOSTUPNÉ	15 × 11 / 40	6,66	80	15 / 1200	72,00 87,20	94,00 113,80	
Kvadra 60		15 × 11 / 60	6,66	50	21 / 1050	135,00 163,40	176,00 213,00	
Kvadra 80		15 × 11 / 80	6,66	40	30 / 1200	216,00 261,40	281,00 340,10	
Kvadra 100		15 × 11 / 100	6,66	40	38 / 1520	275,00 332,80	358,00 433,20	
Kvadra 120		15 × 11 / 120	6,66	25	46 / 1150	342,00 413,90	445,00 538,50	

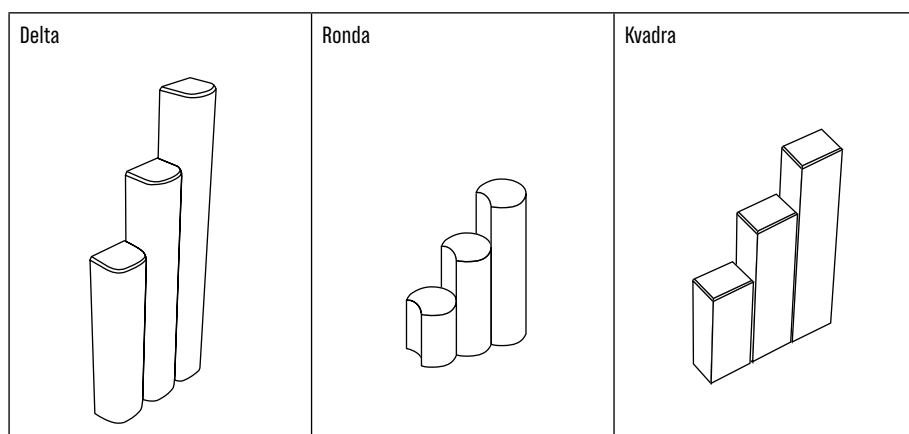

# Obrubníky, meliorační žlab, komínová stříška

Obrubníky hladké					cena bez DPH / ks cena s DPH / ks
Produkt	Rozměry [cm]	Paletizace [ks]	Hmotnost [kg]	Hmotnost kg / paleta	šedá
<b>Obrubník zahradní</b> se zámkem	50 × 5 / 20	88	10,7	942	<b>36,00</b> 43,60

Obrubníky vymývané					cena bez DPH / ks cena s DPH / ks			
Produkt	Rozměry [cm]	Paletizace [ks]	Hmotnost [kg] ks / paleta	oblázek 6-8, 8-10 10-16	povrch standard	povrch elegant	povrch delux	povrch extra delux
<b>Obrubník zahradní</b>	100 × 5 / 30	20	33 / 660	<b>312,00</b> 377,60	<b>359,00</b> 434,40	<b>390,00</b> 471,90	<b>437,00</b> 528,80	<b>499,00</b> 603,80
<b>Obrubník zahradní</b>	50 × 4 / 25	58	11,5 / 667	<b>98,00</b> 118,60	<b>113,00</b> 136,80	<b>123,00</b> 148,90	<b>137,00</b> 165,80	<b>157,00</b> 190,00
<b>Obrubník LUNA</b> oboustranně vymývaný	40 × 5 / 30	60	14 / 840	<b>150,00</b> 181,50	<b>173,00</b> 209,40	<b>188,00</b> 227,50	<b>210,00</b> 254,10	<b>240,00</b> 290,40

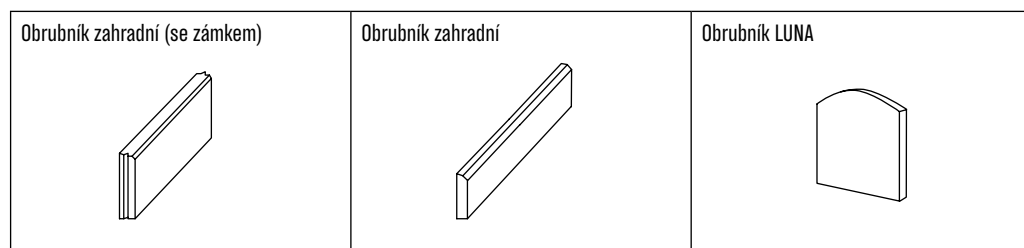

Meliorační žlab				cena bez DPH / ks cena s DPH / ks
Produkt	Spotřeba ks / bm	Paletizace [ks]	Hmotnost [kg] ks / paleta	šedá
<b>Meliorační žlab</b> 33 × 25 / 12	3	60	15 / 900	<b>50,00</b> 60,50

Stříška komínová					cena bez DPH / ks cena s DPH / ks
Produkt	Rozměry [cm]	Určeno pro komín [cm]	Paletizace [ks]	Hmotnost [kg] ks / paleta	šedá
<b>Stříška komínová s otvorem</b>	58 × 58 / 4-5,5	50 × 50	10	55 / 550	<b>743,00</b> 899,10

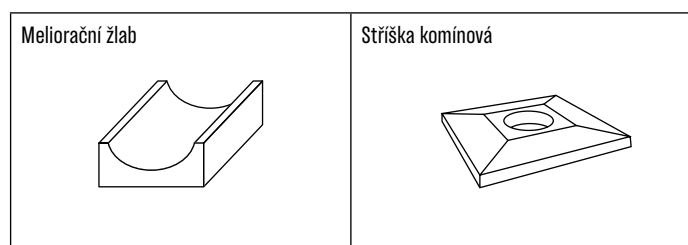



# Vodoměrné šachty

Šachta pro vodovodní přípojku			cena bez DPH / ks cena s DPH / ks
Produkt	Rozměry [cm]	Hmotnost [kg]	šedá
<b>Šachtová nástavba s poklopem</b> poklop 60 × 60	75 × 75 / 20	113	<b>2028,00</b> 2453,90
<b>Šachtová nástavba bez poklopu</b> otvor 60 × 60	75 × 75 / 20	100	<b>1028,00</b> 1243,90
<b>Šachtové víko s otvorem</b> otvor 60 × 60	136 × 106 / 7	174	<b>988,00</b> 1195,50
<b>Šachtové víko s poklopem</b> poklop 60 × 60	136 × 106 / 7	194	<b>2028,00</b> 2453,90
<b>Šachtový segment</b> vnitřní rozměr: 120 × 90 / 50	132 × 102 / 50	355	<b>1718,00</b> 2078,80
<b>Šachtové dno</b> odtokový otvor ø 10cm	136 × 106 / 7	232	<b>988,00</b> 1195,50
<b>SESTAVA 1</b> – 3 segmenty, zákrytová deska s poklopem	136 × 106 / 157	1259	<b>7182,00</b> 8690,30
<b>SESTAVA 1</b> – 3 segmenty, zákrytová deska s poklopem, dno	136 × 106 / 164	1491	<b>8170,00</b> 9885,70
<b>SESTAVA 2</b> – 3 segmenty, zákrytová deska s otvorem, nástavba	136 × 106 / 177	1352	<b>8170,00</b> 9885,70
<b>SESTAVA 2</b> – 3 segmenty, zákrytová deska s otvorem, nástavba, dno	136 × 106 / 184	1584	<b>9158,00</b> 11081,20

Součástí sestav 1 a 2 jsou žebříčky (žárově zinkované).

**Šachtové poklopy jsou pouze pochůzné!**

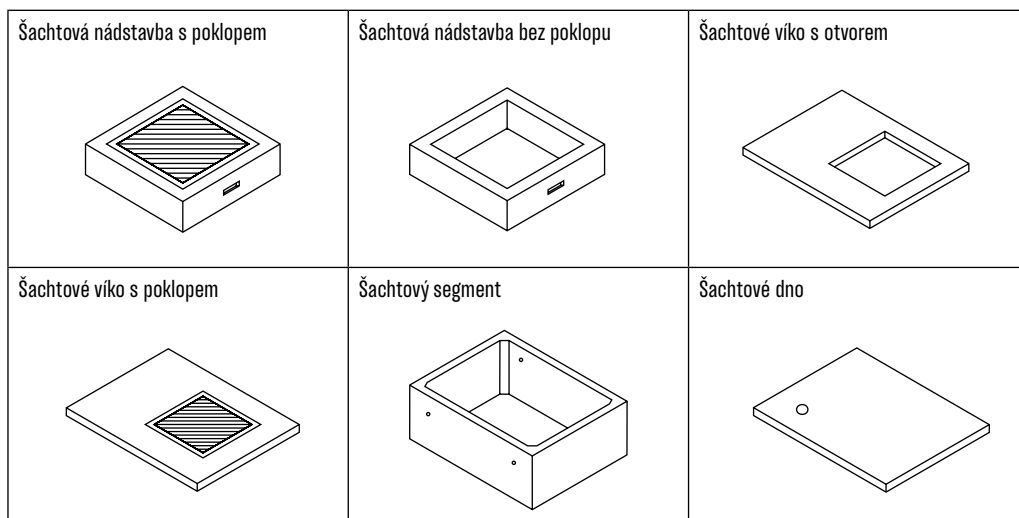

## Paletování

Zboží je baleno na obyčejných paletách o rozměrech 80 × 120 a 100 × 120 cm.  
Palety je možné vyměnit při nakládce, jinak se účtují ve výši 235,- Kč + 21% DPH.  
Při vrácení nepoškozených palet do 2 měsíců bude kupujícímu odečteno 10% z ceny palety za běžné opotřebení.  
Na přepravní obaly je vydáno Prohlášení o splnění podmínek uvedení obalu na trh.  
Firma je zapojena do Systému sdruženého plnění EKO-KOM, a.s. pod klientským číslem EK-F00030015.

## Záruka

### Na betonové výrobky je poskytována záruční lhůta 60 měsíců.

Naše výrobky jsou dle ČSN 73 1326 odolné proti působení vody a chemických rozmrazovacích látek, ale pro prodloužení životnosti vymývaných a hladkých betonových výrobků nedoporučujeme v zimním období používat soli. V případě potřeby doporučujeme ošetřit povrch posypem z přírodních materiálů.

## Barevnost

Při posuzování a výběru výrobků je třeba brát v úvahu skutečnost, že výrobky jsou vyráběny z čistě přírodních materiálů, u nichž dochází ke kolísání barevnosti, která má vliv na výsledný odstín výrobků. Barevné rozdíly výrobků mohou být způsobeny i jejich stářím a vlhkostí. Barevnost výrobků není důvodem k reklamaci.

## Výkvěty

Na povrchu betonových výrobků se mohou vyskytnout nepravidelné bílé povlaky – tzv. "výkvěty". Vznikají nejčastěji následkem difúze hydroxidu vápenatého. Povlak není trvalý a nemá žádný vliv na užité vlastnosti zboží. Zmizí působením klimatických vlivů. Výkvěty nejsou důvodem k reklamaci.

## A. Poplatky

### Objednávky – změny / zrušení

#### I. Standardní zboží

Výrobky vymývané jen v povrchové úpravě oblázek 6–8, 8–10 a ostatní výrobky, které jsou uvedeny v ceníku.

Termín změny	Změna zboží nebo množství	Zrušení objednávky
Nejpozději 5 pracovních dní před expedicí	<b>ZDARMA</b>	
Méně než 5 pracovních dní před expedicí – 1. změna	<b>300,-</b> (bez dph) za jednu paletu nebo poplatek dohodou*	<b>500,-</b> (bez dph) za jednu paletu nebo poplatek dohodou*
Méně než 5 pracovních dní před expedicí – 2. a každá další změna	<b>500,-</b> (bez dph) za jednu paletu nebo poplatek dohodou*	

\*Poplatek dohodou je možný pouze v případech, kdy zboží ke dni požadavku nebylo připraveno k expedici a paleta nebyla zabalena.

#### II. Zakázkové zboží

Výrobky vymývané v ostatních povrchových úpravách (mimo oblázek 6–8, 8–10) a výrobky atypické, které nejsou uvedeny v ceníku.

Termín změny	Změna zboží nebo množství	Zrušení objednávky
Před potvrzením objednávky	<b>ZDARMA</b>	
Po potvrzení objednávky, nejpozději před zahájením výroby	<b>ZDARMA</b>	
Po zahájení výroby	objednávku již vyrobeného zboží nelze stornovat, poplatek <b>100%</b> z prodejní ceny vyrobeného zboží	

## B. Příplatky

### Nakládka zboží

Způsob nakládky	Množství zboží	Cena (bez dph)
Nakládka VZV (vysokozdvížným vozíkem)	Bez omezení	<b>ZDARMA</b>
Nakládka bez VZV, přeložení zboží na paletu zákazníka a přeložení na EURO paletu Tyto služby jsou dostupné pouze v pracovních dnech po–pá, od 7 do 14 hodin.	Množství do 200 kg nebo max. 1/2 objemu palety	<b>250,-</b>
	Množství nad 200 kg nebo nad 1/2 objemu palety	<b>500,-</b>

# Ostatní povrchy

## Povrch hladký beton



## Povrch štípaný



## Povrch trend



Vzorník barevných povrchů se může vlivem tisku lišit od skutečnosti.

**OBJEDNÁVEJTE  
ZBOŽÍ NA NAŠEM  
E-SHOPU**

[www.exterierbeton.cz](http://www.exterierbeton.cz)





**EXTERIER BETON, s.r.o.**  
Holubická 373  
664 07 Pozoříce

[www.exterierbeton.cz](http://www.exterierbeton.cz)